

CONTENTS

	<u>PAGE</u>
Chapter One - Grounding is Safety _____	1
Chapter Two - The Circuit _____	19
Chapter Three - Insulation _____	36
Chapter Four - Reactance _____	40
Chapter Five - Earth and Electrodes _____	48
Chapter Six - Bonding _____	60
Chapter Seven - Impedance Grounded Systems _____	77
Chapter Eight - The Code _____	82
Chapter Eight - Summary _____	174
Chapter Nine - Exams _____	189
Final Exam _____	240
Answers _____	247

Grounding

The white grounded wire is never fused unless the device is designed to open all ungrounded (hot) conductors at the same time it opens the grounded conductor. The sketch below shows the fuse **properly** located in the ungrounded (hot) conductor. When the **fuse blows**, the wire to the motor has no voltage.

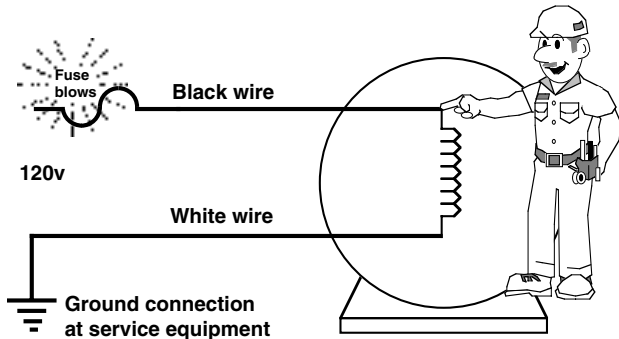

The sketch below shows the fuse **improperly** located in the white grounded wire. Now when the **fuse blows** the black wire is still hot.

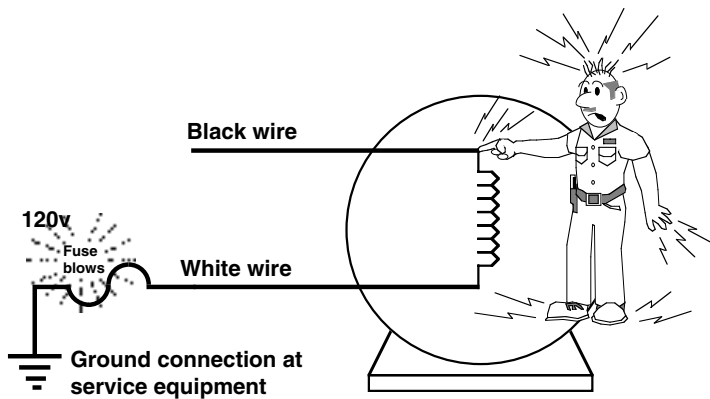

The sketch below shows the fuse in the proper location, the fuse is **not** blown, the motor winding accidentally touches the metal motor housing. This is called a **ground-fault** condition. If someone touches the motor frame they become the path to ground experiencing electrical shock.

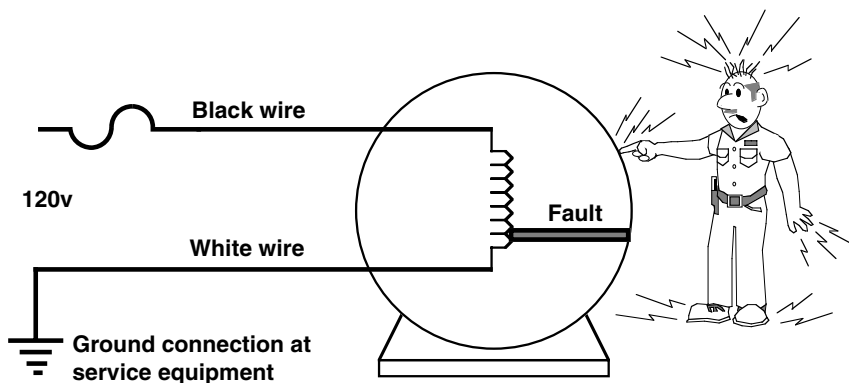

Grounding

The sketch below shows an **equipment grounding conductor** connected to the metal motor housing and running back to the service ground connection. The equipment grounding conductor is the **path** for the **ground-fault current to travel back to trip the breaker or blow the fuse** when a ground-fault occurs.

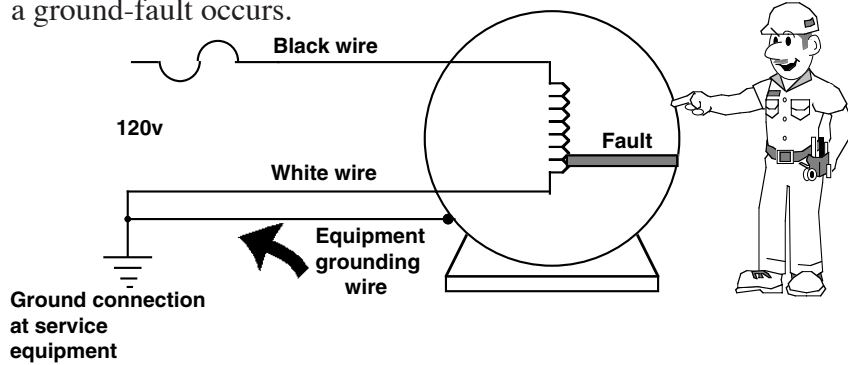

The **equipment grounding** conductor may be insulated (green in color) or **bare**. Conduits and different raceway systems can serve as the equipment grounding conductor. The equipment grounding conductor only carries current during a **fault condition**. The duration of time this current should be flowing on this conductor is approximately 1/2 of a cycle, which is **1/120 of a second** on a normal 60 cycle AC system. This current will flow quickly through the path of low impedance and trip the breaker or blow the fuse.

The sketch below shows a single-phase 240 volt motor which would not have a grounded conductor since the voltage is 240v and not 120v; but, the circuit is required to have an **equipment grounding conductor**. With the winding faulting to the metal frame, a hazardous condition will exist without an equipment grounding conductor.

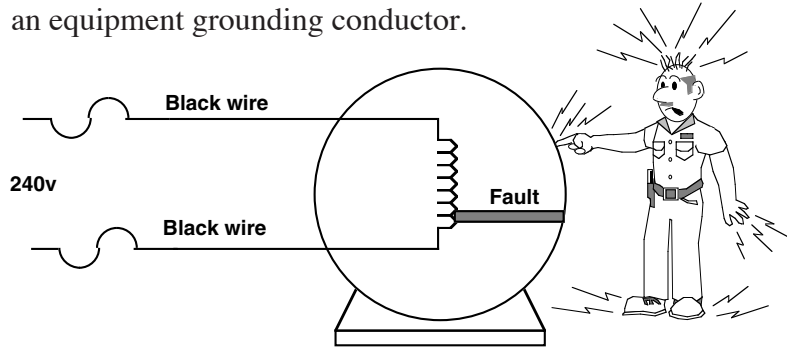

The circuit below is connected so the equipment grounding conductor will carry fault current back to trip the breaker or blow the fuse.

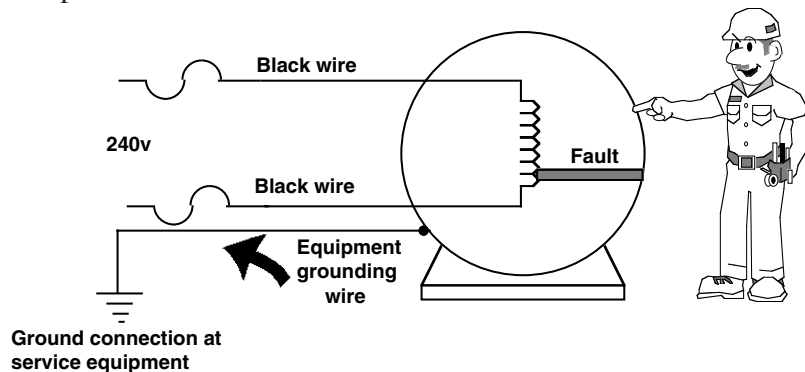

Grounding

The equipment grounding conductor actually forms a shunt around a person. It provides the path of **least resistance** for the current to flow.

A person's body has resistance, the **outer skin has a higher resistance** than the inside of the human body. Once the outer skin has been penetrated, the inside of the body is liquid, mostly salt water which has low resistance and the body becomes a good conductor and allows current to flow easily through it.

1,000 feet of #12 copper wire has a resistance of only 1.98 ohms which is much **less** resistance than a person's skin; consequently, the ground-fault current shown in the sketch will flow through the equipment grounding conductor rather than the person. If the grounding circuit is effectively grounded, the circuit breaker will trip within 1/120th of a second.

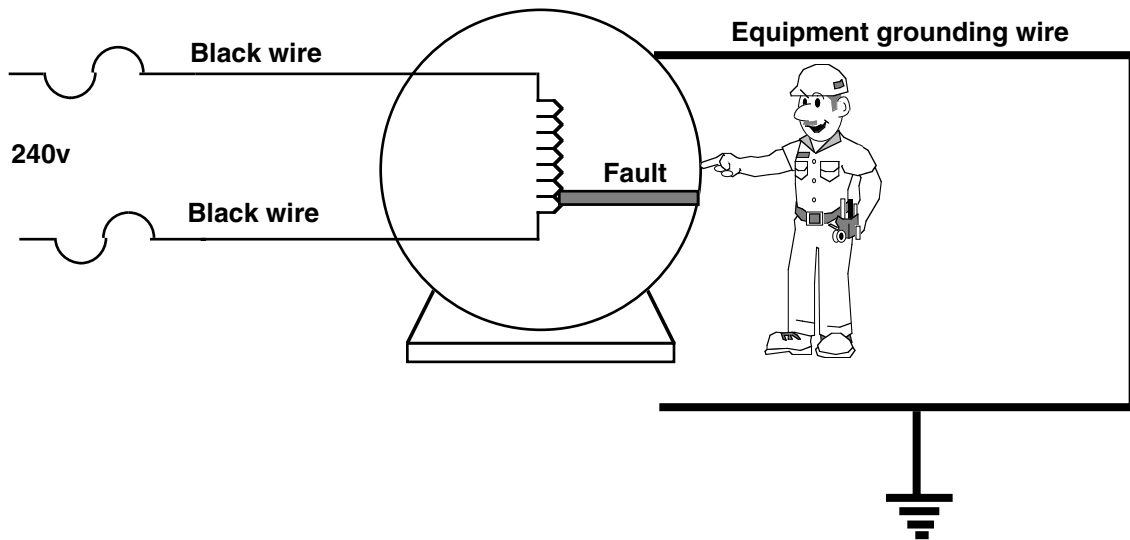

There is an advantage in using metal raceway verses cable when wiring a circuit. If a **bare** spot in an insulated conductor touches the metal conduit, the current will follow the effective grounding path and trip the breaker. With a **nonmetallic** cable, a bare spot on the hot conductor could go undetected until someone touches it.

The disadvantage using metal conduit as the equipment grounding path is all the connections, set-screws and compression fittings and connections at each box throughout must be tight and secured.



Grounding



The importance of the **equipment grounding conductor** to a hand held tool with a metal frame such as a drill motor, circular saw, hedge trimmers, etc. is shown below.

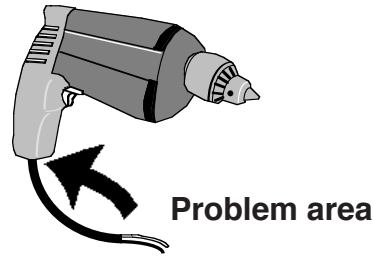

After a period of time and usage, the 2-wire cord has been known to wear at the point where the cord enters the metal frame. This is the most likely problem area for insulation break down.

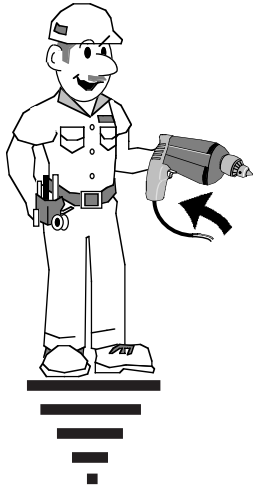

If the white grounded conductor opens due to a break in the conductor, the path to ground in the 2-wire circuit would now be the person holding the drill motor with the metal frame.

If the black (hot) wire would wear a bare spot in the insulation and touch the metal frame, the person holding the tool could become the path of least resistance to ground.

Adding the third wire to the cord, the green equipment grounding conductor provides a direct path to ground when a problem occurs as mentioned above. Current will flow over the grounding conductor and back to the panelboard to trip the breaker and protect you.

Even if the breaker does not trip, the grounding conductor reduces the voltage to almost zero as compared with the ground the person is standing on.

At garage sales, I have seen hand-held metal frame tools with no grounding conductor or the grounding pin has been cut off from the male plug so it will plug into a 2-wire nongrounding receptacle. This tool becomes an "electrocution special." When the insulation in the cord breaks down and the bare wire touches the metal frame, you become the path to ground when there is no equipment grounding conductor.

Double-insulated tools and GFCI receptacles and breakers have come into our industry to help provide the safety needed in this area.



Grounding

We all have experienced an electrical shock at one time or another. You can receive an electrical shock by walking across carpet and touching a metal grounded object. This is called static electricity, the oldest form of electricity. Static electricity was discovered by the ancient Greek's by rubbing two objects together.

When is a shock considered dangerous is a question often asked. Several factors are involved which will determine the level of shock.

Most people think that high-voltage is the main cause of fatal electrocutions. Actually, it's the amount of current passing through the body that determines the effect of a shock; currents over 15 mA are dangerous, over 75 mA could be fatal. Of course the higher the voltage, the more chance there is of pushing more current through the body.

We are not talking about 15 or 75 amperes, **an mA is one-thousandth of an ampere**. mA means milliamperes = .001.

A shock from 1 to 7 mA a person can feel, from 8 to 15 mA is a strong shock but a person can usually release themselves from it. Currents over 15 mA usually causes the body to "muscular freeze" and the person is unable to release from the current and often results in death. Currents over 75 mA are considered fatal.

The degree of shock depends on the surface on which you are standing (dry or wet), condition of your skin at point of contact (dry or wet), and your general health. Pure water is not a good conductor, but salt water, dirty water, or water with added chemicals becomes a good conductor and will cause maximum shock. Shocks of less than 120 volts can be fatal.

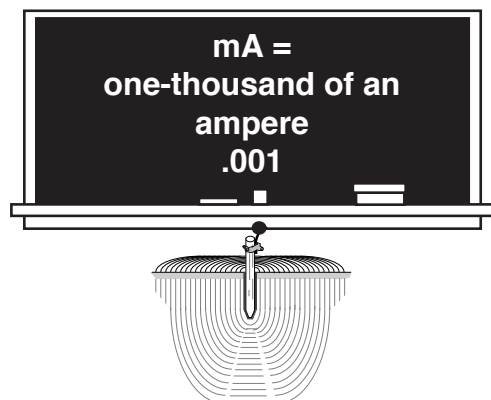

Grounding

Remember we are talking about 15 mA causing muscular freeze and over 75 mA death.

15 mA = **.015 amperes**

75 mA = **.075 amperes**

Let's use a standard light bulb to show current flow.

Ohm's law $I = W \div E$

A 25 watt @ 120 volt light bulb would have a current flow of $25w \div 120v =$ **.208 amperes or 208 mA**

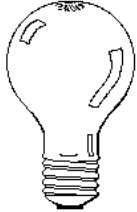

A 60 watt @ 120 volt bulb would have a current flow of $60w \div 120v =$ **.5 ampere or 500 mA**

A 100 watt @ 120 volt bulb would have a current flow of $100w \div 120v =$ **.833 ampere or 833 mA**

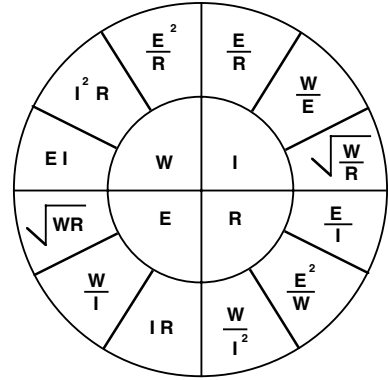

These numbers far exceed the **75 mA fatal range**. The 208 mA current drawn from a 25w bulb could be fatal under certain conditions.

Again the level of current and shock depends on the conditions which involve the resistance.

A 25 watt @ 120 volt bulb has a resistance of $25w \div (.208a \times .208a) =$ **578 ohms**

A 60 watt @ 120 volt bulb has a resistance of $60w \div (.5a \times .5a) =$ **240 ohms**

A 100 watt @ 120 volt bulb has a resistance of $100w \div (.833a \times .833a) =$ **144 ohms**

As you can see, with **more** resistance, less current is flowing. So depending on a person's individual body resistance and the resistance to ground of the area in which you are standing, will determine the amount of current flow through your body.

People have been known to survive a shock of over 600 volts and yet a shock from under 120 volts can be fatal.

A good example is a spark plug. If you touch one it could be energized with over 15,000 volts, but the current is nil.

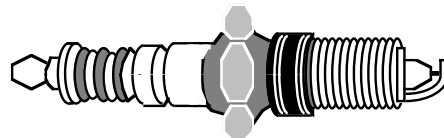

As I write this chapter, I can't help but think of the electrician I worked with years ago in the industry. He would remove a burnt out light bulb and then stick his finger into the socket to see if he had voltage rather than use a voltage tester or try another bulb. He must have a high skin resistance, maybe even mica! You can see by now the dangerous risk involved with something so foolish.

For added safety, there are two types of ground-fault protective devices.

GROUND-FAULT PROTECTION FOR PERSONS
GROUND-FAULT PROTECTION FOR ELECTRICAL EQUIPMENT

A ground-fault circuit interrupter (GFCI), a people protector, can be either a circuit breaker or a receptacle.

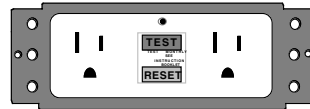
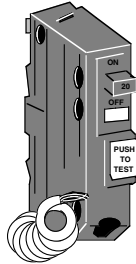

In a 2-wire single-phase branch circuit under normal conditions, the current flow (amperes) is the same in the black wire as in the white wire.

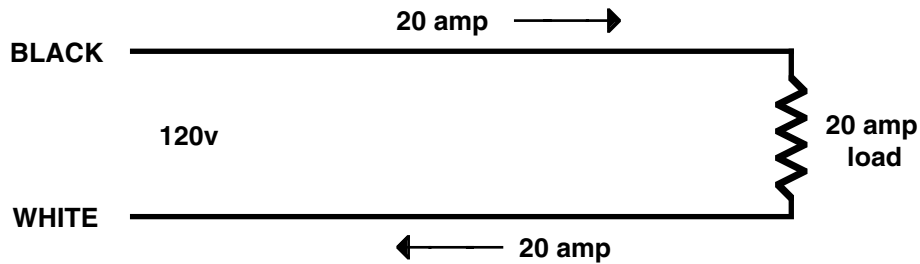

The sketch below shows a ground-fault in which the black wire makes contact with the metal conduit. This fault allows a leakage of current to flow on the metal conduit.

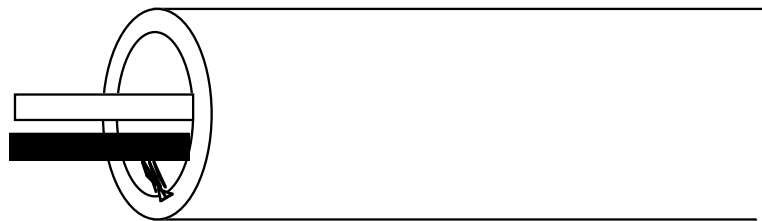

Black wire has a fault which leaks current to the metal conduit

Grounding

A GFCI has a built-in differential transformer which uses a magnetic field to measure the flow of current on the black wire and the flow of current on the white wire.

Under **normal** conditions, the current flow would be the same in both wires. But, with a ground-fault leak to metal conduit, the current in one wire **does not equal** the current flowing in the other wire. When this happens, the induction in the secondary winding of the transformer will cause the sensing unit to operate the GFCI.

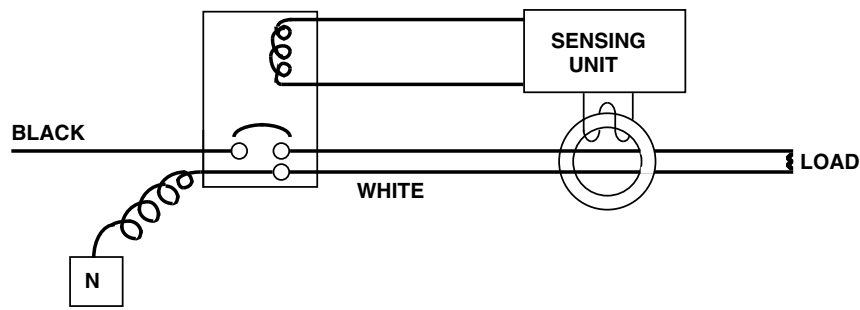

The GFCI will trip at **4 to 6 milliamperes**. The GFCI constantly monitors the flow of current in a circuit. If the current going out to the load differs by **.005 amperes** from the current coming back from the load, the GFCI acts quickly and disconnects the circuit.

As you can see, the GFCI tripping between 4 to 6 mA is **less** than the 15 mA which could cause a person to have "muscular freeze" during an electrical shock.

The GFCI will **not** prevent a person from receiving a shock, but the shock will be minor.

As the name implies, ("Ground-fault Circuit Interrupter"), the GFCI does not protect a person that touches **both** wires at the same time. The device protects from ground-faults not short-circuits. Phase-to-phase short-circuit protection is the responsibility of the overcurrent device.

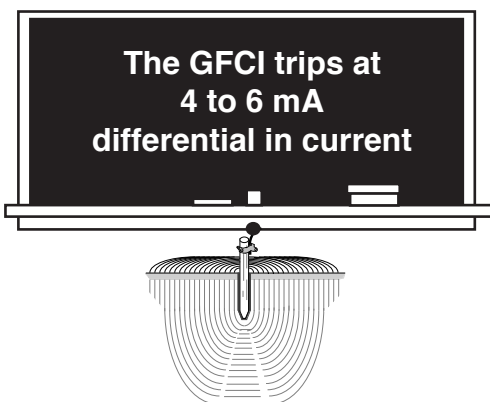

GFCI TEST MONTHLY?

It's marked on the receptacle. The instructions sheet that came with the GFCI states this also.

Are we telling the occupants of the dwelling this is to be done?

In the preceding sketch, a neutral conductor was not needed to trip the circuit breaker in a short circuit condition. The sketch below shows a fault-current from line-to-metal. The neutral is grounded at the transformer **but the neutral is not run to the service**.

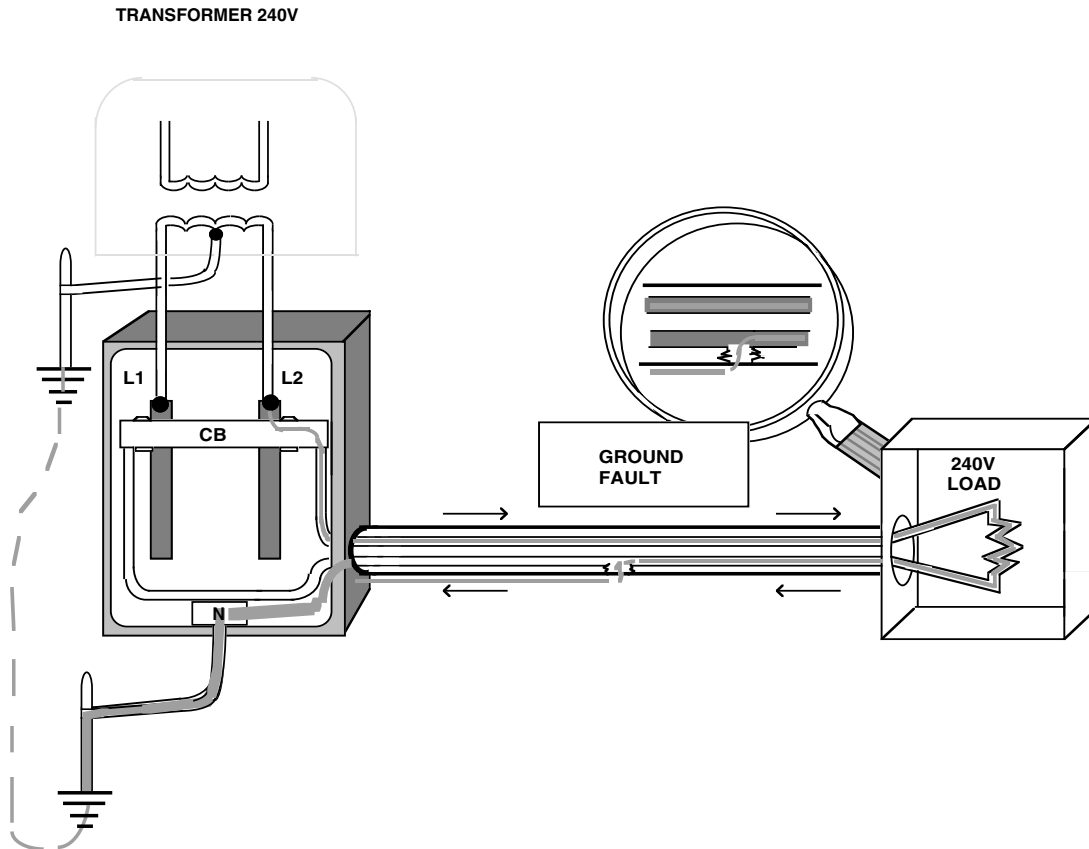

The sketch above shows no neutral conductor from the service panel back to the transformer. The path of fault-current must now travel through the ground rod into the high-impedance earth path to the ground rod at the transformer. Not enough current will ever reach the circuit breaker through this high-impedance path.

OHMIC HEATING



A loose connection causing the voltage to drop at the terminal using the wattage to create heat and carbonize the connection. **The current flow in amperage of 3 to 7 amps is not high enough for a 15 amp fuse or 15 amp circuit breaker to open the circuit.**

There is no protection against the high-resistance, loose connections creating ohmic heat and glow faults in the walls and attics. **No practical circuit breaker could detect such a fault** as there is no measureable characteristic that any circuit breaker could employ to distinguish a glow fault from the normal operation of a branch circuit.

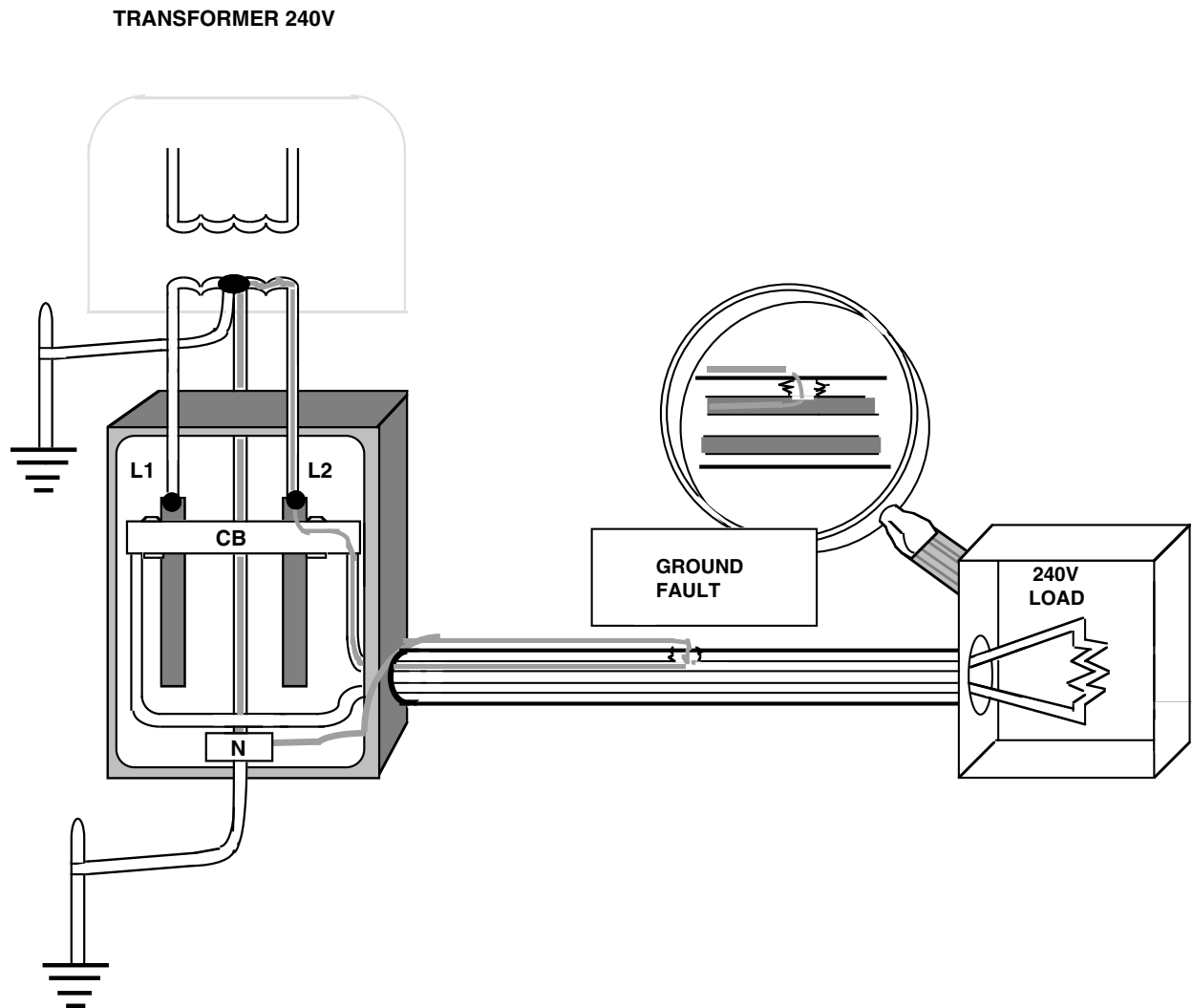

The sketch above shows the 240v circuit with the **neutral conductor** to the service from the transformer. With a fault-current, the current travels the metal raceway through the metal service enclosure through the neutral bus which is bonded at the service to the metal service enclosure and flows through the neutral conductor through the transformer to the circuit breaker. With a properly connected effective grounding path, we will have plenty of fault-current to trip the circuit breaker.

Now you can realize the importance of a neutral conductor being installed with the service conductors **even though there are NO neutral loads**.

Grounding

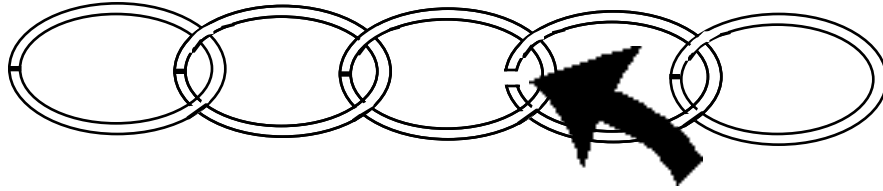

The effective grounding path is like a chain. It is as strong as its weakest link. The mechanical connections of conduits and boxes are a vital factor in the strength of the grounding path.

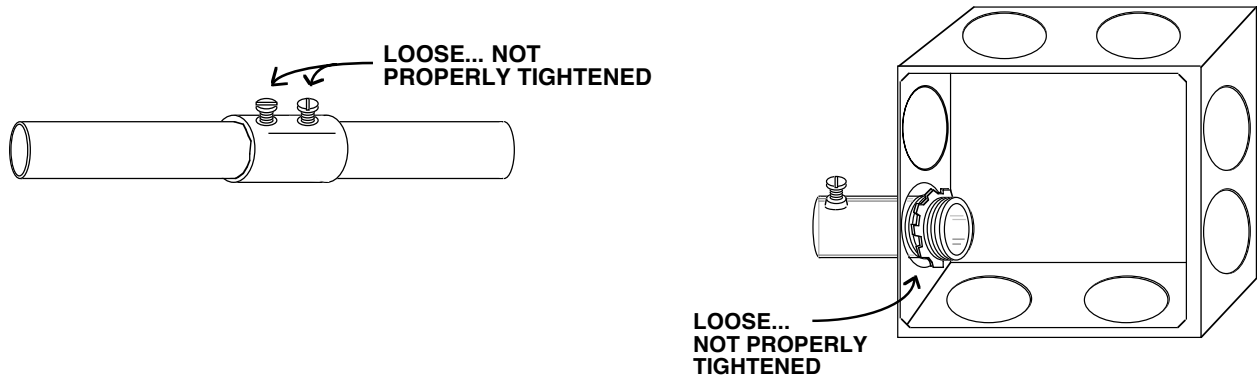

The sketch shown below shows a loosely connected conduit which adds a 7 ohm resistance at the loose connection. The current flow in the ground path would be $I = E \div R$ $240v \div 7\Omega = 34.3$ amperes.

The 50 amp circuit breaker would not trip at 34.3 amperes and the ground-fault is allowed to continue to heat until serious damage may occur.

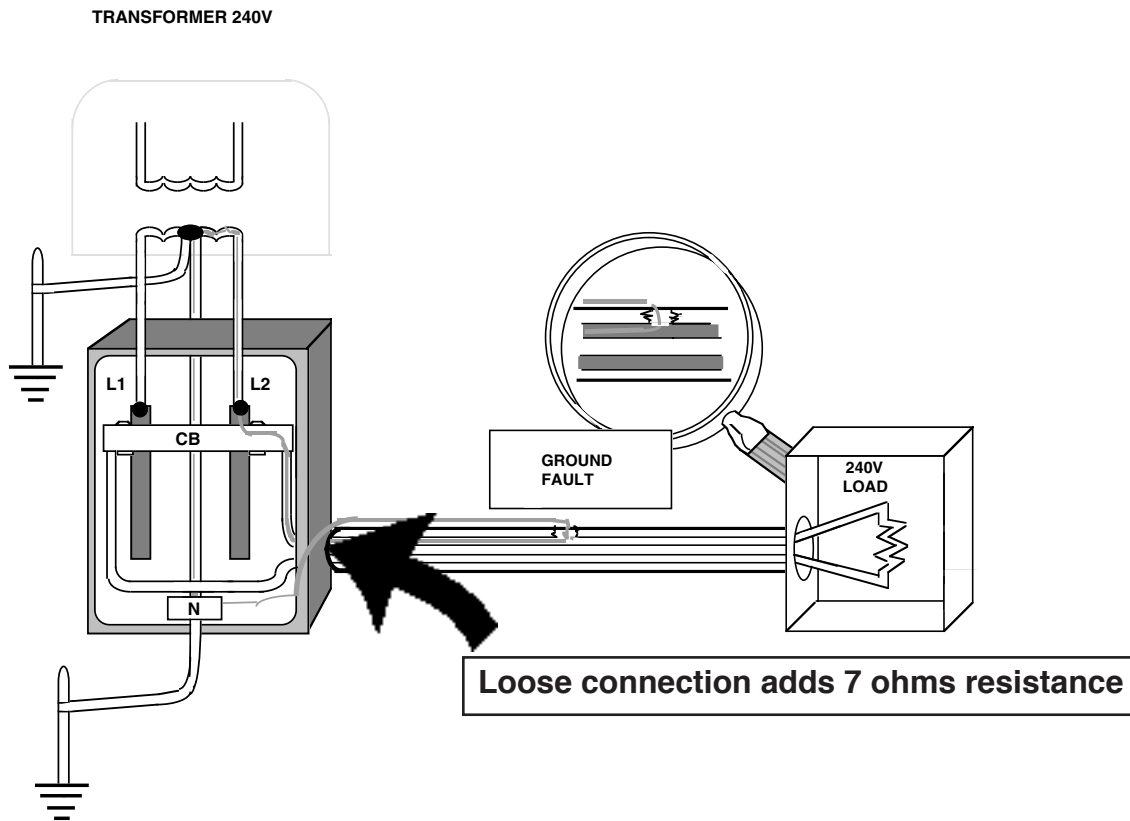

There are many misconceptions about the cause of an electrical fire. Do you realize an electrical fire can start in a receptacle box that has nothing plugged into the receptacle?

The sketch below shows a 15 amp rated living room branch circuit where the chair was set fire from a duplex receptacle where nothing was plugged into the receptacles. How can this happen?

Just because nothing is plugged into the receptacle does not eliminate it as a possible hazard.

The receptacle is one of many receptacle outlets in this branch circuit. At any splice, where a wire is connected by a screw or wire nut, you have a possible electrical hazard. When you plug something into a branch circuit such as the portable heater shown in the sketch you cause a resistance, and everything down stream in the branch circuit has a **load** on it. If you have a **loose splice or connection**, you have a high-resistance connection which causes **heat**. Remember, the chain is as strong as the **weakest link**.

In the circuit mentioned above, when the heater is turned on, this heater **load** is flowing through the entire circuit wiring, any weak connection in this circuit can cause a hazard.

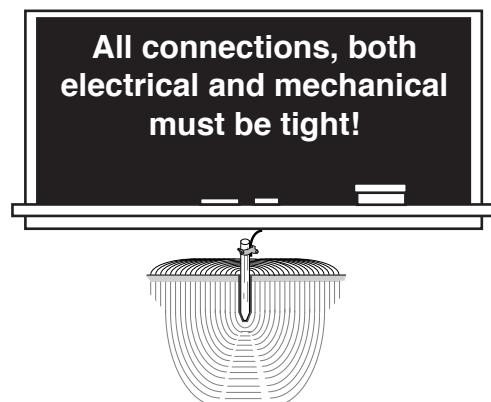
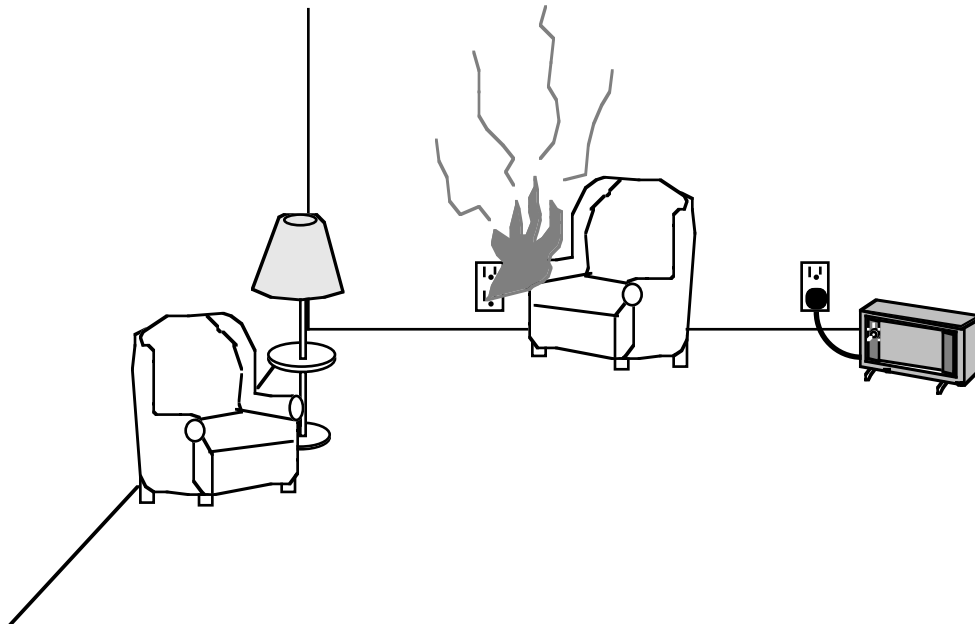

250.24(A)(1)

The sketch below shows the neutral bus in the service panel properly *bonded* to the panel and electrode. The service equipment enclosure is called the "bullseye" of grounding. The service equipment is the only location where all the grounding is connected together.

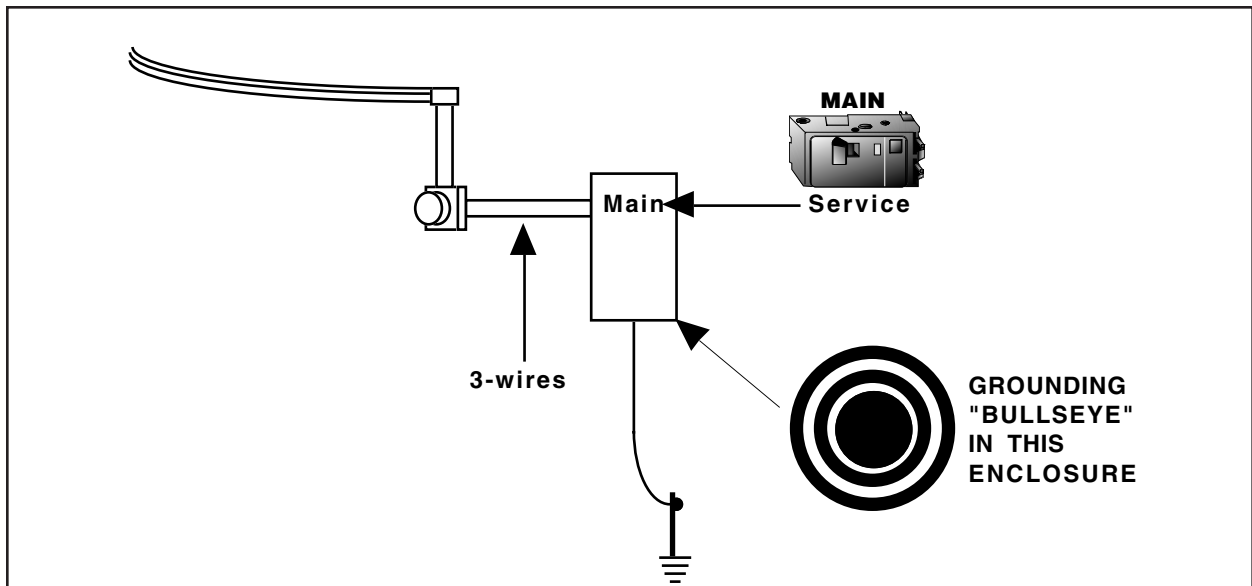
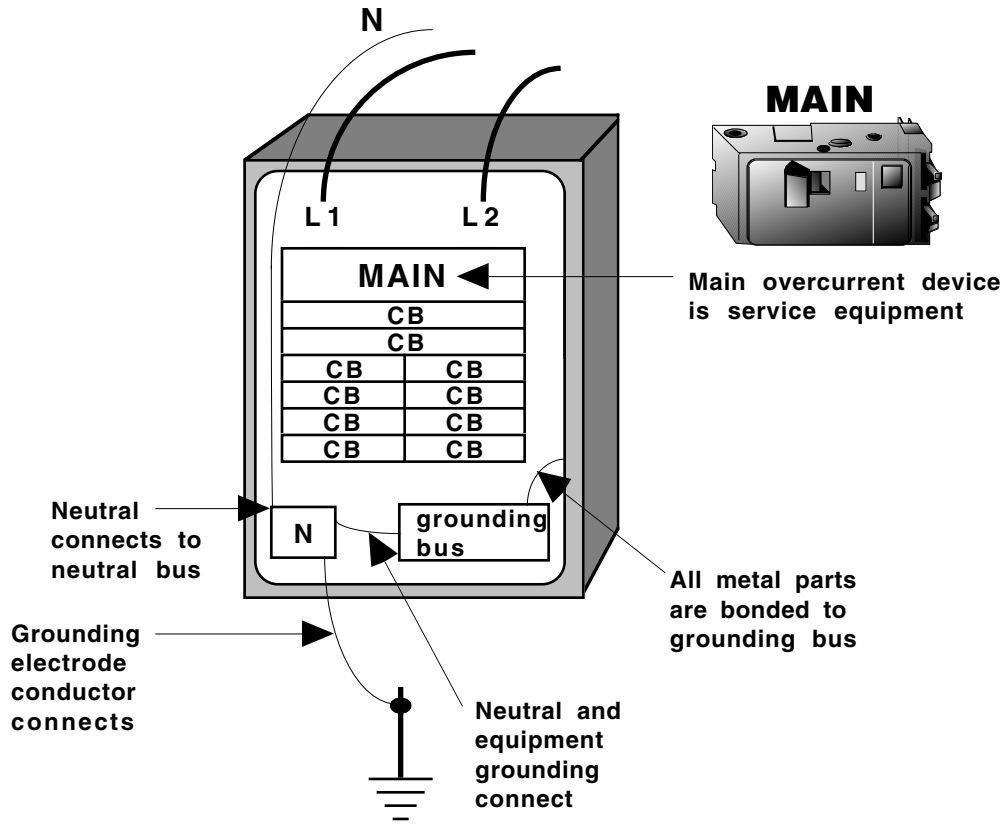

250.24(A)(2)

250.24(A)(2). The rule states that the grounding electrode conductor must be connected to the service conductor within the service disconnect or on the supply side of the service disconnect.

The sketch below shows an electrode connected at the meter on the pole. This does **not** satisfy the Code intent. The service disconnect is located in the barn and not on the pole. The Code states the connection of the grounding electrode conductor, grounding conductor, and grounded neutral conductor must be made on the supply side of the **service equipment** in the barn.

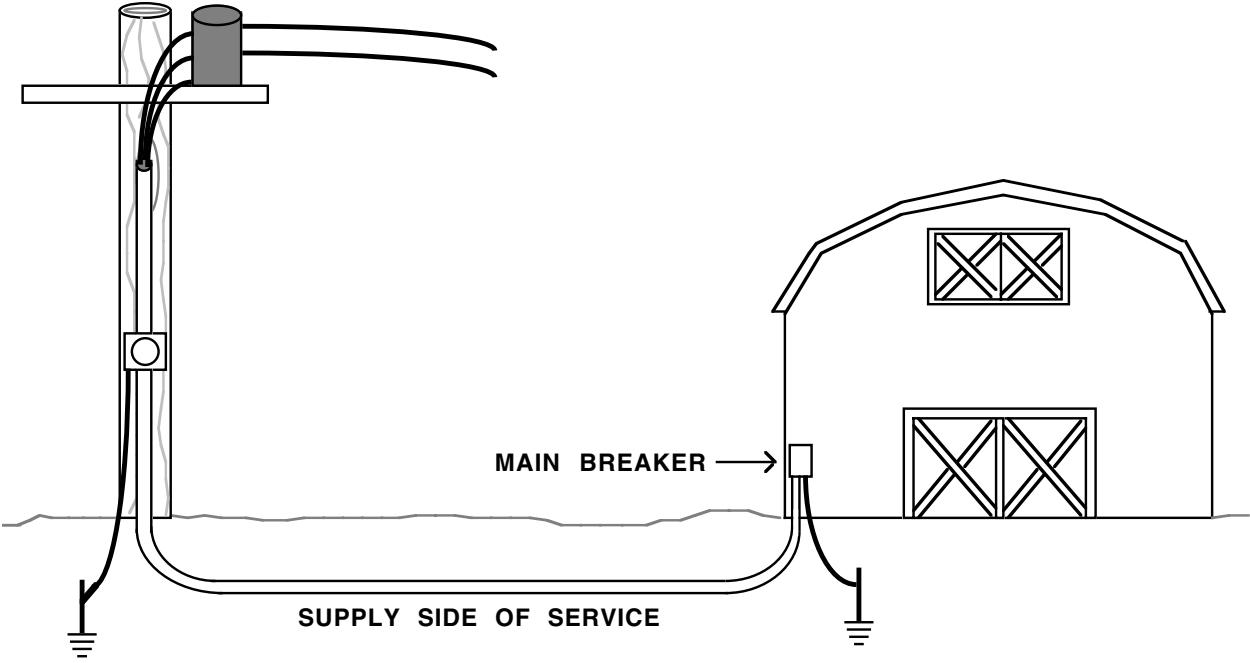

Service equipment consists of the circuit breaker or fused switch to disconnect the main source of supply

The diagram shows a service equipment panel with a grounding electrode conductor connected to a ground rod.

250.24(A)(3)

(3) For services that are dual fed in a common enclosure or grouped together in separate enclosures and employing a secondary tie, a single grounding electrode conductor connection to the tie point of the grounded conductors from each power source is permitted.

(4) Permits the grounding electrode conductor to be connected to the equipment grounding bus in the service panel instead of the neutral bus. Example, when using a CT-type sensor on the ground strap between the grounding bus and the neutral bus.

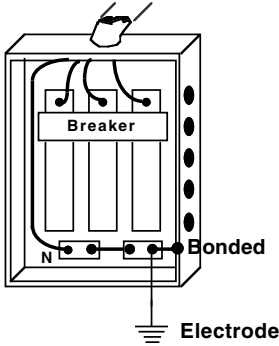

(B) A grounding connection shall **not** be made to any grounded conductor or reconnected to ground on the load side of the service disconnecting means except as otherwise permitted by Article 250.

250.24(D). When a service supply transformer has a grounded neutral, the grounded neutral conductor must be brought into the service-entrance equipment even if the distribution on the load side is all three-phase, three-wire or single-phase with all the loads 240v with no neutrally connected loads.

This was explained in Chapter Two. Running the neutral conductor from the transformer to the service equipment provides a low-impedance ground-fault path to open the overcurrent device. Without the neutral conductor, the ground-fault path would be planet earth, the high resistance path as we learned earlier. **During the fault, the neutral becomes the equipment grounding conductor.**

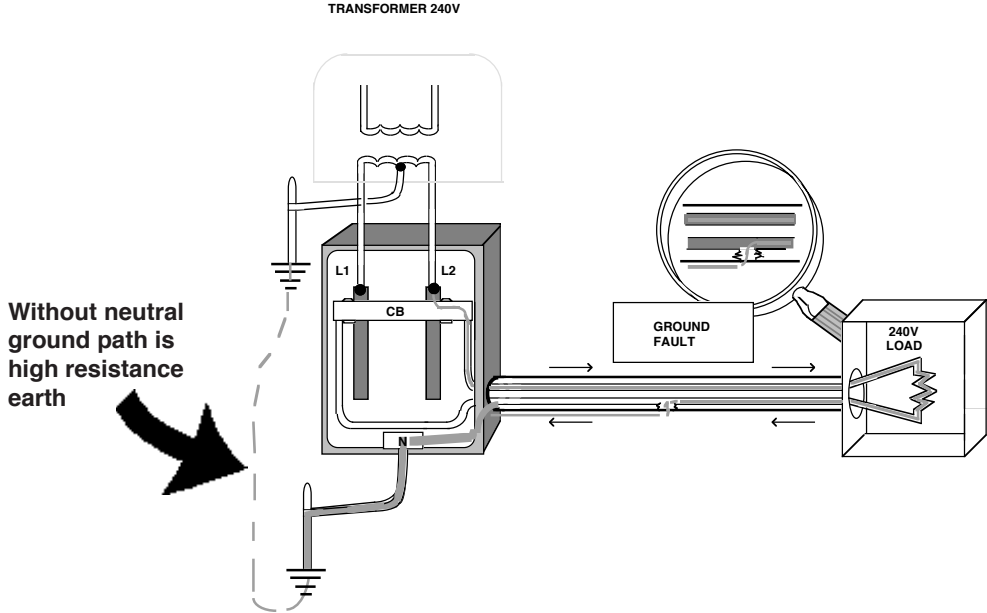

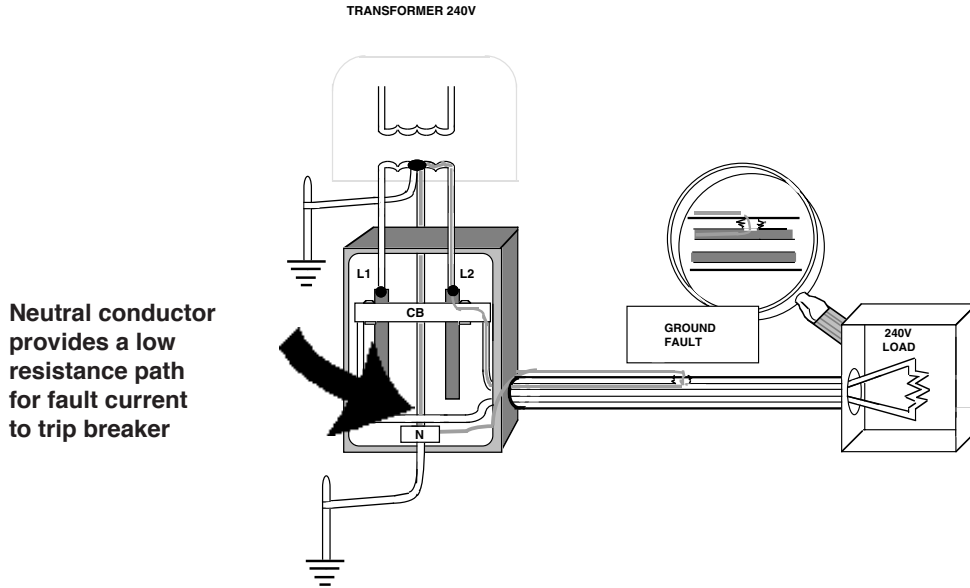

250.24(D)(1). The size of the grounded neutral conductor for a single raceway shall **not** be smaller than specified in Table 250.102(C)(1).

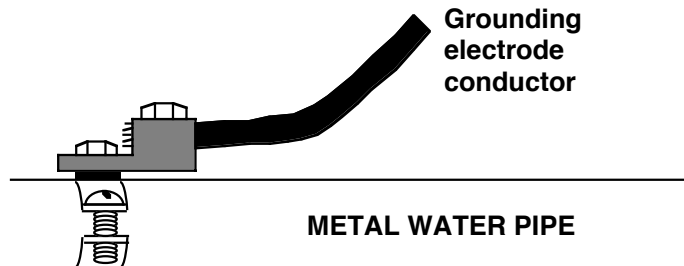

For sets of ungrounded service entrance conductors **larger** than 1100 kcmil copper or 1750 kcmil aluminum, the grounded neutral conductor shall not be smaller than **12 1/2 %** of the circular mil area of the largest set of service-entrance ungrounded conductors. These calculations apply to a grounded neutral conductor brought from the transformer to the service equipment **not** used as a circuit conductor. When calculating the neutral conductor size supplying neutral loads, you would apply Article 220 for calculating.

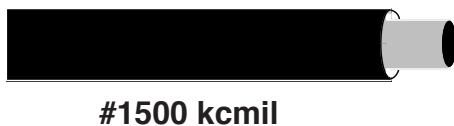

An example would be a #1500 kcmil copper service-entrance conductor which would require a minimum size #4/0 neutral conductor.

$1500 \text{ kcmil} \times 12.5\% = 187,500 \text{ cm}$ required. Table 8 shows a #3/0 at 167,000 cm is **not** large enough. A #1500 kcmil would require a #4/0 at 211,600 cm. You need a conductor with **at least** 187,500cm.

250.24(D)(2)

250.24(D)(2) When the service conductors are **paralleled**, the size of the grounded neutral conductor shall be based on the total paralleled cma.

Two #2/0 copper conductors paralleled would have a total cma of 133,100 (Table 8) x 2 = 266,200 cm. Table 250.102(C)(1) would require a **minimum** neutral conductor of #2 copper for a #300 kcmil phase conductor.

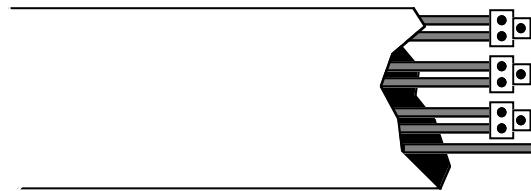

Example, 4 - #300 kcmil conductors paralleled would have a total cma of 300 kcmil x 4 = 1200 kcmil which is **larger than** 1100 kcmil. 1200 kcmil x 12.5 % = 150,000 cm. Table 8 shows a #3/0 at 167,800 cm. The **minimum** grounded neutral conductor would be a #3/0.

Refer to 310.10(G)(1) which states the **minimum size** conductor that can be paralleled is a #1/0. This rule comes into play when installing **multiple conduits** for paralleled conductors.

Example, four - 500 kcmil copper service conductors are paralleled using **four conduits**. 4 x 500 kcmil = 2000 kcmil x 12.5% = 250 kcmil. The Code permits subdividing the 250 kcmil by the **number of conduits containing the conductors**. 250,000 cm/4 conduits = 62,500cm required for the neutral in **each conduit**. Table 8 shows a #2 conductor at 66,360 cm. **But**, 310.10(G)(1) does not permit a #2 to be installed in parallel, so each of the **four conduits** would have a **minimum** #1/0 conductor for the grounded neutral conductor.

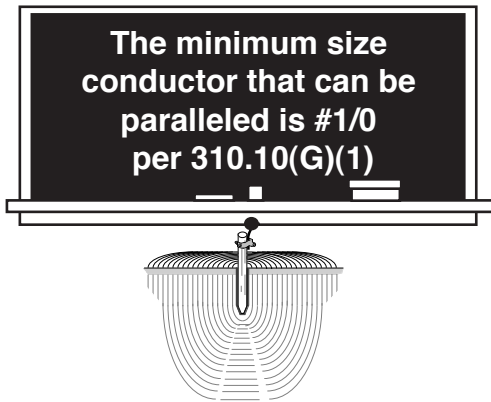
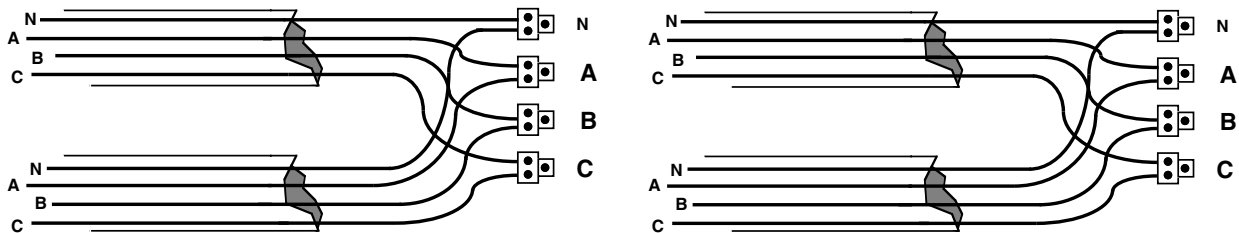

250.24(E). A grounding electrode conductor shall be used to connect the equipment grounding conductors, the service-equipment enclosures, and, where the system is grounded, the grounded service conductor to the grounding electrode(s) required by Part III of this article. This conductor shall be sized in accordance with Table 250.66.

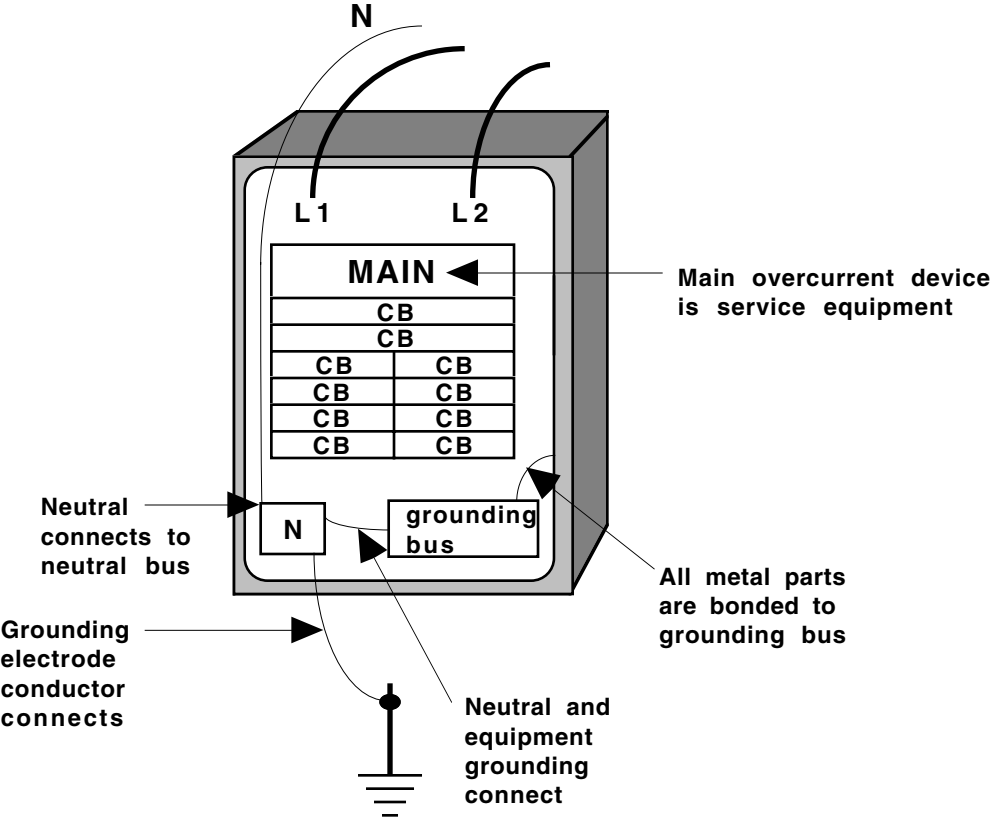

250.24(F). A premises wiring system that is supplied by an AC service this is **ungrounded** shall have, at each service, a grounding electrode conductor connected to the grounding electrodes(s) required by Part III of this article. The grounding electrode conductor shall be connected to a metal enclosure of the service conductors at any accessible point from the load end of the service drop or service lateral to the service disconnecting means.

CHAPTER 8 FINAL OPEN BOOK EXAM 20

• *Open book exam check answer and fill in Code section.*

1. Grounding a separately derived system located outdoors, the grounding electrode shall be as near as practicable and shall be ____.

- I. the nearest available effectively grounded structural metal member of the structure.
- II. the nearest available effectively grounded metal water pipe.

(a) I only (b) II only (c) I or II (d) both I and II
Code section _____.

2. The earth shall not be used as the sole equipment grounding conductor.

(a) true (b) false
Code section _____.

3. An industrial plant has several step-down delta-wye 480/208/120v transformers. Each separately derived system has its own grounding electrode. The Code does not require these electrodes to be bonded together.

(a) true (b) false
Code section _____.

4. Short sections of raceway used to enclose service conductors shall be grounded.

(a) true (b) false
Code section _____.

5. To be effectively grounded as the Code requires, the grounding path shall ____.

- I. have sufficiently low impedance to limit the voltage to ground and to facilitate the operation of the circuit protective devices in the circuit.
- II. have capacity to conduct safely any fault current likely to be imposed on it.
- III. be permanent and continuous.

(a) I only (b) II only (c) III only (d) I and II
Code section _____.

FINAL EXAM Continued

6. In which of the following can the neutral also be used as an equipment grounding conductor on the load side of the service?

- I. electric range
- II. counter-mounted cooktop
- III. junction box which is part of the appliance circuit
- IV. clothes dryer

(a) I and IV only (b) I and II only (c) I, II and IV only (d) I, II, III and IV

Code section _____.

7. A fusible service disconnect is tapped from the service entrance conductors in a gutter. The tap from the gutter to the fusible service disconnect does not require a neutral conductor since the service has no neutral loads.

(a) true (b) false

Code section _____.

8. Rigid schedule 80 PVC cannot be used for mechanical protection of a grounding electrode conductor.

(a) true (b) false

Code section _____.

9. Flexible metal conduit or liquidtight flex may be used for any length of run, provided an equipment grounding conductor is installed inside the flex.

(a) true (b) false

Code section _____.

10. Threadless EMT connectors and couplings (indenter, compression, set-screw type) are permitted for bonding for over 250 volts to ground.

(a) true (b) false

Code section _____.

11. A branch circuit for an electric range is fed from a subpanel using #6 - 3 conductor nonmetallic sheathed cable (romex) with all the conductors insulated. The grounded neutral (white) conductor can be used to ground the frame of the range.

(a) true (b) false

Code section _____.

FINAL EXAM Continued

12. To avoid bonding around concentric knockout rings where required, all the rings can be removed and a larger conduit installed.

(a) true (b) false

Code section _____.

13. An underground feeder supplying a barn where livestock are housed shall have an equipment grounding conductor that is insulated.

(a) true (b) false

Code section _____.

14. The ground rod must have a low resistance to earth to facilitate the operation of the overcurrent devices in the circuit.

(a) true (b) false

Code section _____.

15. A metal underground water pipe is the only electrode that requires being supplemented by another electrode.

(a) true (b) false

Code section _____.

16. Two electrodes effectively bonded together are treated as a double electrode system.

(a) true (b) false

Code section _____.

17. The 240/120v single-phase service has a main breaker on the outside of the residence. Four conductors are run from the main breaker enclosure to the distribution panel inside. From the distribution panel to the electric range an SE cable with a bare neutral is installed using the bare neutral to ground the frame of the range.

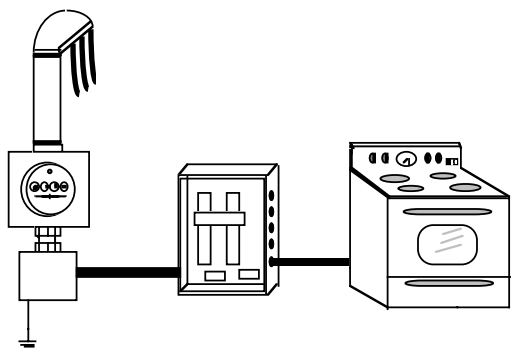

OKAY

VIOLATION

Code section _____.

FINAL EXAM Continued

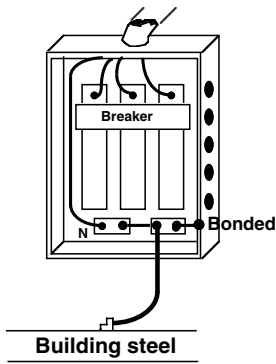

18. The service entrance conductors for a 480/277v three-phase system are one #750 kcmil aluminum per phase. What size aluminum grounding electrode conductor is required to connect to the building steel? # _____.

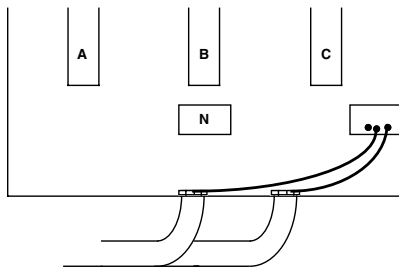

19. Two - #750 kcmil THW copper conductors are paralleled per phase. The overcurrent device protecting the circuit is 800 amperes. What size copper equipment grounding conductor is required for each PVC conduit? # _____.

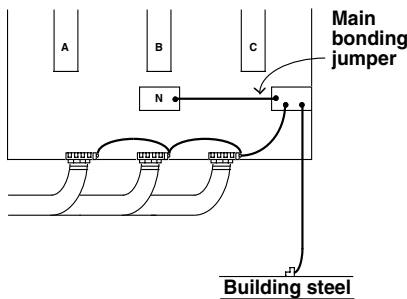

20. The service entrance contains 3 - #400 kcmil copper conductors paralleled per phase. What size copper main bonding jumper is required? # _____. What size copper equipment bonding jumper is required between conduits? # _____.

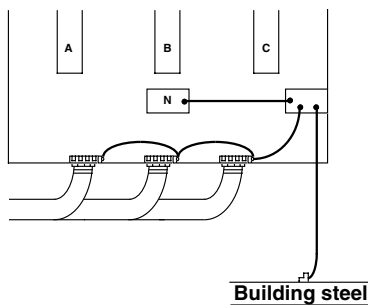

21. The service entrance contains 3 - #400 kcmil copper conductors paralleled per phase. What size copper grounding electrode conductor is required? # _____.

FINAL EXAM Continued

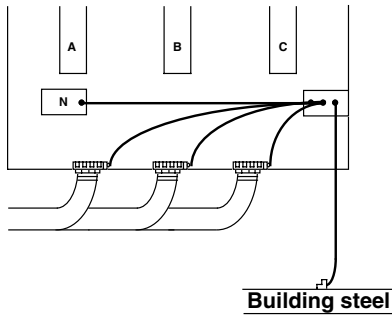

22. Each conduit contains 4 - #350 kcmil copper service conductors A-B-C-N. The largest phase conductor in each conduit is #350 kcmil. Each conduit has an individual bonding jumper connecting to the grounding bus. What size copper bonding jumper is required for each conduit? # _____.

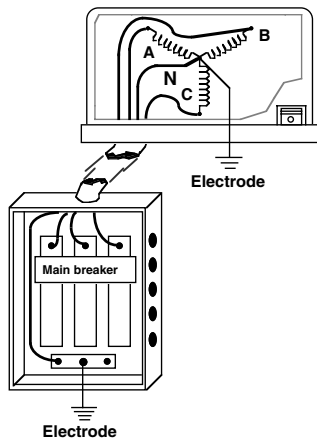

23. The service supply transformer has a grounded neutral, even though the distribution on the load side has all three-phase loads, no neutral loads, the Code still requires a neutral conductor to be installed from the transformer to the service panel. The service conductors are #750 kcmil THW copper conductors per phase. The main circuit breaker is 400 amperes. What size copper neutral conductor is required by the Code? # _____.

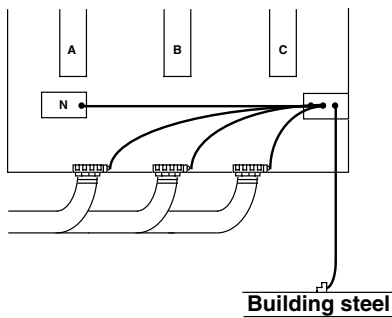

24. Each conduit contains 4 - #500 kcmil aluminum conductors A-B-C-N. The largest phase conductor in each conduit is #500 kcmil. Each conduit has an individual bonding jumper connecting to the grounding bus. What size aluminum bonding jumper is required for each conduit? # _____.

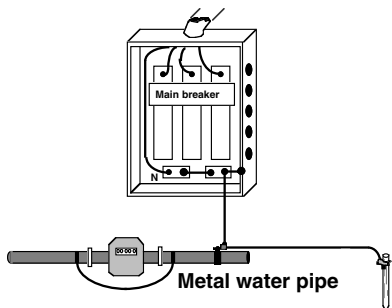

25. A three-phase service has #250 kcmil THW copper service entrance conductors. What size copper bonding jumper is required to bond around the water meter? # _____.