CONTENTS

	<u>PAGE</u>
Article 220 - Calculations _____	1
Article 220 - Quiz _____	35
Article 225 - Outside Branch-Circuits and Feeders _____	45
Article 225 - Quiz _____	64
Article 230 - Services _____	67
Article 235 - Branch Circuits, Feeders, Services over 1000v _____	119
Article 230 - Quiz #1 _____	127
Article 240 - Overcurrent Protection _____	135
Article 242 - Overvoltage Protection Over 1000 volts _____	178
Article 245 - Overcurrent Protection Over 1000 volts _____	181
Article 240 - Quiz #1 _____	184
Final Exam One _____	188
Final Exam Two _____	193
Final Exam Three _____	197
Final Exam Four _____	202
Answers _____	206

PART I - BRANCH CIRCUITS

220.1. Article 220 is a large section of the Code which provides the minimum requirements for branch circuits, feeders and service calculations.

Article 220 is divided into seven parts:

- PART I - GENERAL - 220.1 - 220.5**
- PART II - BRANCH CIRCUITS - 220.10 through 220.18**
- PART III - FEEDERS - 220.40 through 220.61**
- PART IV - OPTIONAL - 220.80 through 220.88**
- PART V - FARM LOADS - 220.100 through 220.103**
- PART VI - HEALTH CARE FACILITIES - 220.110**
- PART VII - MARINAS, BOATYARDS, FLOATHING BUILDINGS, and COMMERCIAL and NONCOMMERCIAL DOCKING FACILITIES**

Part II is referred to as the GENERAL METHOD of calculation for feeders and service conductors. This method of calculation can be used for any type of occupancy. The OPTIONAL METHOD of calculation is limited to dwellings, schools and restaurants.

It is very important that the student, when studying this Article of the Code, note which part of Article 220 you are reading from. The requirements change when you go from GENERAL METHOD to OPTIONAL METHOD.



Table 220.3. Additional load calculation references are listed in this Table.

220.5(A). Unless other voltages are given for calculations, a nominal system voltage of 120/240, 208Y/120, 480Y/277, 600Y/347, and 600 volts shall be used.



220.5(B). Fractions .5 and larger are rounded up to the nearest whole ampere, with decimal fractions smaller than .5 dropped.

220.5(C) Floor Area. Each floor shall be calculated from the outside dimensions of the building. For dwelling units, the calculated floor area shall not include open porches or unfinished areas not adaptable for future use as a habitable room or occupiable space.

220.11. The maximum load on a branch circuit shall not exceed the rating of the branch circuit.

220.11(B). Inductive and LED lighting loads for supplying lighting units that have ballasts, transformers, autotransformers, or LED drivers, the calculated load shall be based on the total amperage ratings of such units and not on the total watts of the lamps.

220.14. Branch circuit load calculations shall include calculation of a minimum load on each outlet.

220.14(A). Specific Appliances or Loads. An outlet for a specific or other load not covered in 220.14(B) through (K) shall be calculated based on the ampere rating of the appliance or load served,

220.14(B). An outlet for a specific appliance, other than a motor, shall be the ampere rating of the appliance. Load computations from Table 220.54 for dryers and T. 220.55 and ranges is permitted.

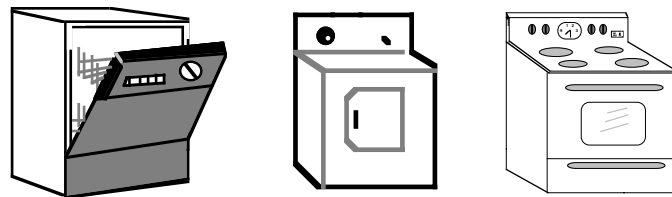

220.14(C). Outlets for motor loads are from sections 430.22, 430.24 and 440.6.

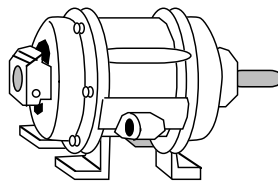

220.14(D). Outlets supplying luminaire(s) shall be the maximum va of the equipment and lamps for which the fixture is rated.

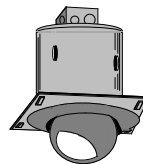

220.14(E). Heavy duty lampholders are computed at 600 va minimum.



220.14(F). For sign and outline lighting, 1200 va for each required branch circuit specified in Section 600.5(A).

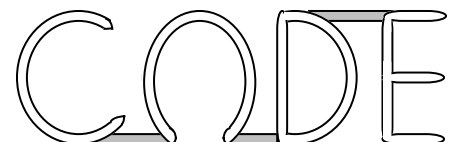

220.14(G)

220.14(G). Show window lighting is computed at a minimum of 200 va per foot.

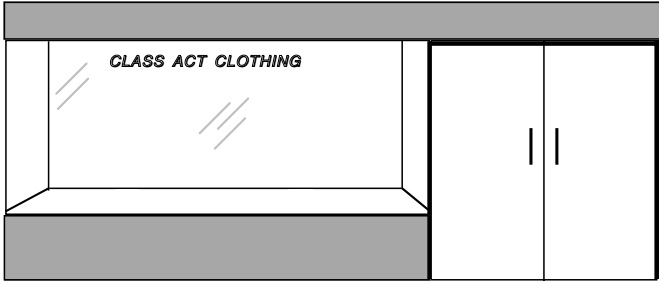

220.14(H). Each 5 feet of multioutlet assembly shall be considered as one outlet at 180 va. Where a number of appliances are likely to be used at the same time, each foot of multioutlet assembly shall be computed at 180 va. This does not apply to dwellings or guest rooms of motels or hotels.



220.14(I). Other than for dwelling outlets, 180 va shall be used per outlet.

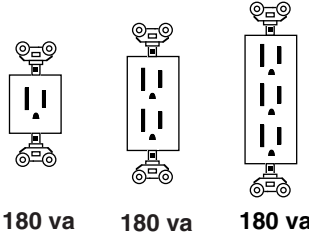

For each single or multiple receptacle, one strap counts as 180 va. A mounting strap is referred to as a "yoke". A multiple receptacle comprised of four or more receptacles shall be computed at not less than 90va per receptacle.

220.14(J). In office buildings, the receptacle loads shall be calculated to be the larger of 220.14(I) after all demand factors have been applied or 1 volt-ampere per sq.ft. for unknown receptacles.



220.14(K). Other outlets not covered in 220.14(A) through (J) shall be based on 180 va per outlet.

220.16(A). Additions to an existing dwelling shall be calculated to 220.14. When wiring new circuits in an existing residence, the circuits shall be in accordance with 220.14.

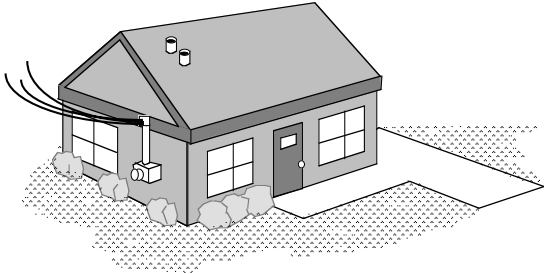
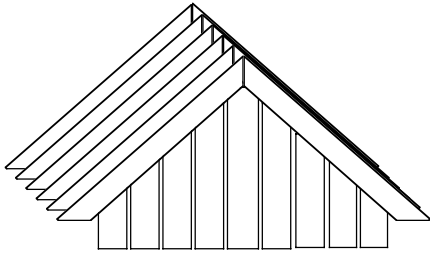

220.16(B). Loads for an existing building, other than a dwelling, the new or extended circuits shall be computed in accordance with 220.42 or 220.14.

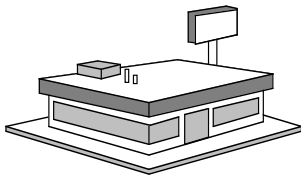

RESTAURANT

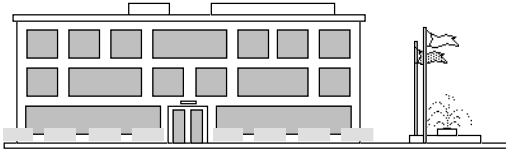

OFFICE BUILDING

PART III - FEEDERS and SERVICE

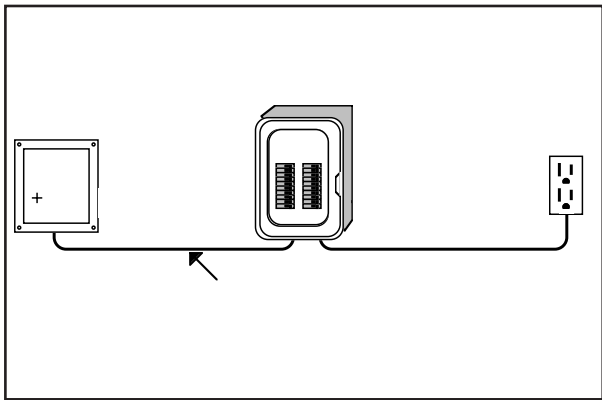

Feeder:
The circuit conductors between the service equipment, the source of a separately derived system, or other power supply source and the final branch circuit overcurrent device.

220.40. The calculated load of a feeder or service cannot be smaller than the sum of the branch circuit loads after the demand factors have been applied. Feeder or service conductors shall have the required ampacity to serve the loads.



Informational Note. The examples in Annex D are very helpful.

220.41. Dwelling Units. In one-family, two-family, and multifamily dwellings, the minimum unit load shall not be less than 3 volt-amperes per square foot. The lighting and receptacle outlets are included in the 3 volt-amperes and no additional load calculations is required.

In a **dwelling** there is no limit placed on the number of outlets connected to a general lighting or small appliance branch circuit. The more receptacles you have reduces the number of extension cords in use. These are commonly called convenience receptacles.

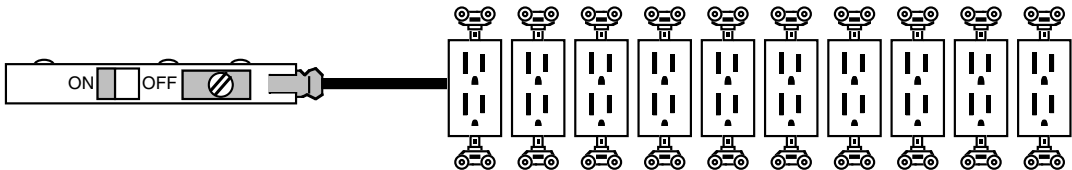

For "other" than a dwelling, 180va per strap is computed.

Example: How many receptacle outlets can be installed on a 20 amp, 120v branch circuit?
 $20a \times 120v = 2,400va$. $2,400va \div 180va = \mathbf{13 \text{ receptacle outlets maximum}}$.

220.42. A demand factor from Table 220.45 can be applied to the total connected load on a feeder. Most electricians size conductors to the connected nameplate load. A demand factor is a **reduction** in the size of a conductor from the nameplate load.

The demand factor does not apply in determining the number of branch circuits for general illumination.

A demand factor permits sizing of a feeder according to the amount of load that operates at the same time.

The general lighting load is computed for the receptacles and general illumination branch circuits.

To calculate the minimum size service to a dwelling, the first step is to multiply the living area square footage by 3 volt amps. This is called the general lighting load. The 3 volt amps are from 220.41 which is the minimum unit load per square foot for a dwelling.

A 1,500 sq. ft. house $\times 3va = 4,500va$.

A demand factor from Table 220.45 is applied to the 4,500va:

$$\begin{array}{l} \text{First } 3,000 \text{ va @ } 100\% = 3,000va \\ \text{Next } 1,500va \text{ @ } 35\% = \frac{525va}{3,525va} \end{array}$$

The maximum demand load for the general lighting is 3,525va.

220.42(A)(I.N.) Table 220.42(A) is based on minimum load conditions and 80% power factor.



220.43. In office buildings, the receptacle loads shall be calculated to be the larger of 220.14(I) after all demand factors have been applied or 1 volt-ampere per sq.ft. for unknown receptacles.



220.44. In guest rooms or guest suites of hotels and motels, the lighting and receptacle outlets specified are included in the minimum unit load in Table 220.42(A). No additional load calculations shall be required for such outlets.



A demand factor is allowed from Table 220.45 for dwellings, hotels and motels, and warehouses.

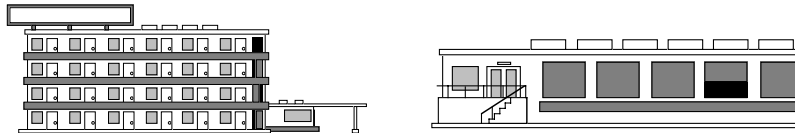

All other occupancies compute at 100%. There is no demand for general lighting as it is assumed that all the general lighting will be operating at the same time.

The demand factor is applied in sizing the feeder or service conductor. The demand factor is **not** applied when determining the number of branch circuits required.

For a 1,500 sq.ft. house, the minimum number of 15 amp circuits required for general lighting would be computed: $1,500 \text{ sq. ft.} \times 3\text{va} = 4,500\text{va} \div 120\text{v} = 37.5$ amperes. This would require 3 - 15 amp branch circuits for general lighting. The demand factor is **not** applied when computing branch circuits.

Table 220.45 lists a demand factor for dwellings and a different demand factor for apartments without provisions for cooking by tenants.

220.41 lists a unit load of 3va for a dwelling. Definition of a dwelling is it has permanent provisions for living, sleeping, **cooking**, and sanitation.

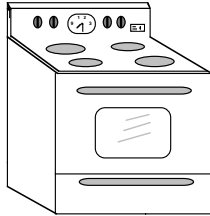
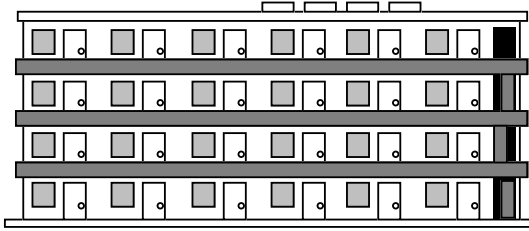

An apartment can become a dwelling by installing **permanent provisions for cooking** and the demand factor and unit load per square foot would change from Table 220.42(A) 1.7 va to 3va.

220.46. Show window lighting requires a minimum of 200va per linear foot for the feeder or service calculation. This can amount to a considerable load. Example: A 40 foot show window would require $40 \times 200va = 8,000va$ which would be equivalent to an 8kw electric range.

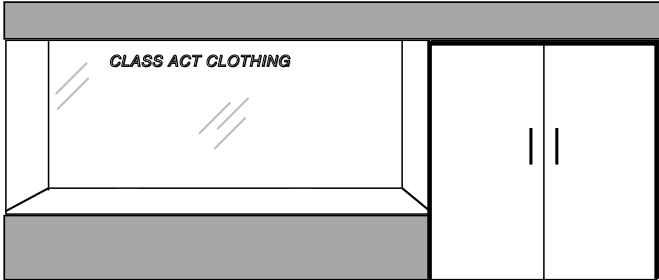

Informational Note. Section 220.14(G) requires **200va** for the branch circuit receptacle rather than 180va.

220.46(B). For branch circuit calculations, 2 feet of track lighting or a fraction thereof is calculated at 150va.

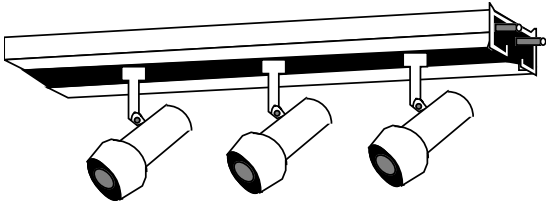

Exception. If the track lighting is supplied by a device that limits the amount of current to the track, the load can be based on the rating of the device used to limit the current.

220.47. For *nondwelling* units a demand factor is permitted for receptacle loads over 10 kva per Table 220.47.

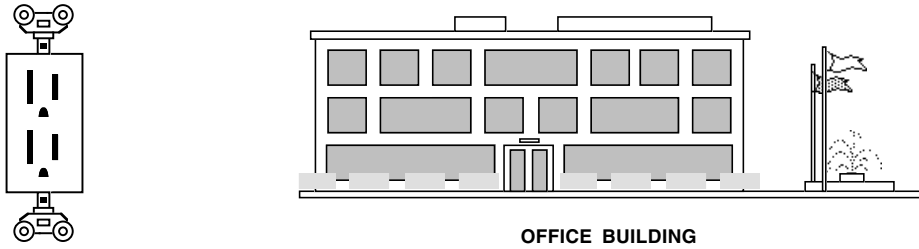

Table 220.47 allows a demand factor of 50% for receptacle loads over 10 kva.

Example: An office building with a total receptacle load of 18 kva.
 First 10 kva @ 100% = 10 kva
 Next 8 kva @ 50% = 4 kva
 14 kva maximum demand load

56 receptacles and over can have a demand factor applied. 56 receptacles x 180va = 10,080va.

Example: What is the maximum demand for 75 receptacles in an office building?
 75 receptacles x 180va = 13,500va ÷ 1000 = 13.5 kva.
 First 10 kva @ 100% = 10 kva
 Next 3.5 kva @ 50% = 1.75 kva
 11.75 kva

Receptacle loads can have a demand factor applied from Table 220.45 general lighting or from Table 220.47.

Example: A hotel has 300 receptacles in addition to those in the guest rooms. What is the demand on the service for these receptacles?

220.47 states you can use Table 220.45 or Table 220.47 demand factors.

Using **Table 220.47**: 300 receptacles x 180va = 54,000va ÷ 1000 = 54 kva.
 First 10 kva @ 100% = 10 kva
 Next 44 kva @ 50% = 22 kva
 32 kva

Using **Table 220.45**: 300 receptacles x 180va = 54,000va
 First 20,000va @ 50% = 10,000va
 Next 34,000va @ 40% = 13,600va
 23,600va ÷ 1000 = **23.6 kva.**

23.6 kva is the best demand since it is the lowest value.

220.50. Motors have their own rules for sizing from Article 430.

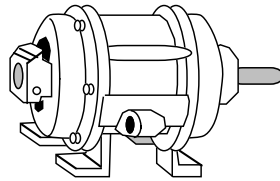

220.51. Fixed electric space heating shall be computed at 100%.

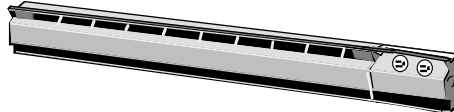

Exception. When heat units are connected so that all of them cannot operate at the same time, permission may be given for the feeder conductors to be reduced in size.

220.52(A). The Code requires for each dwelling unit to have a minimum of two small appliance circuits. For the branch circuit these are 20 amp rated circuits. When calculating the size of the feeder or service conductor, each small appliance circuit is computed at 1,500va each. The demand factor from Table 220.45 for general lighting can also be applied to the small appliances.

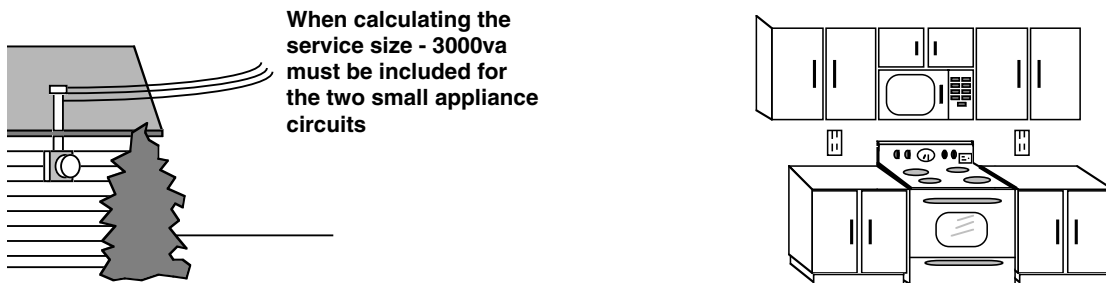

220.52(B). A load of 1,500va shall also be included in the feeder or service conductor for the laundry. Table 220.45 demand factor for general lighting also applies to the laundry.

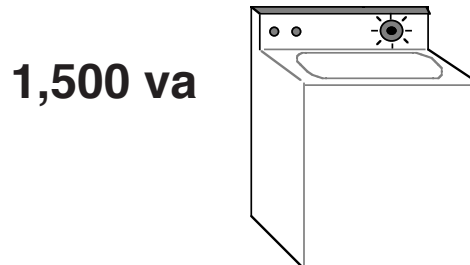

Part I General

230.1 Scope. This article covers service conductors and equipment for control and protection of services not over 1000 volts ac or 1500 volts dc, nominal and their installation requirements.

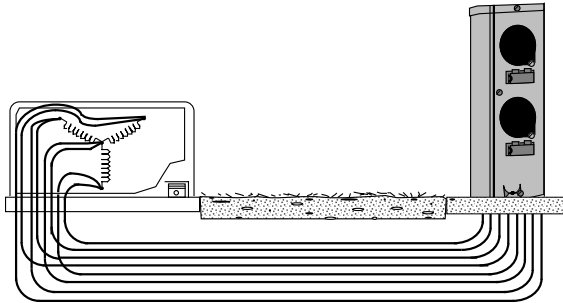
230.2 Number of Services.

This allows two to six sets of service lateral conductors, #1/0 or larger, connected together at their supply end but not connected together at their load end to be considered as **one** service lateral.

There are special conditions to the general rule that covers two or more service drops or laterals to a single building.

230.2(A)(1). This permits a separate service for fire pumps. The intent of this special condition is when disconnecting the main service to the building, you would **not** want to disconnect fire fighting equipment.

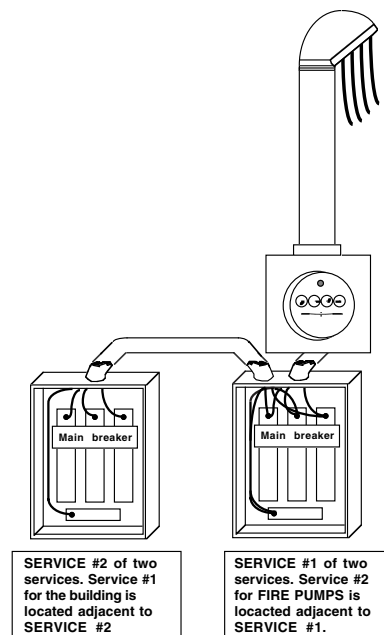

230.2(A)(2) This special condition permits a separate service for emergency systems, standby systems or parallel power production systems.

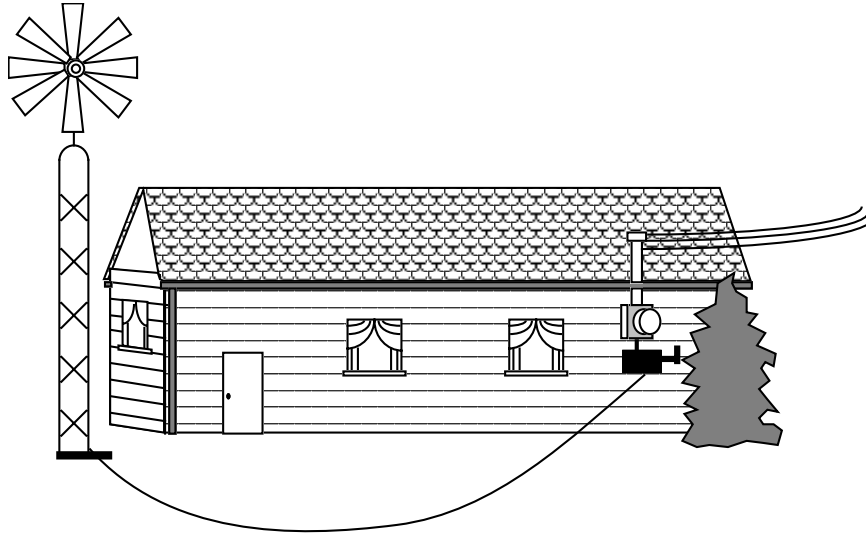

230.2(B). By special permission by the authority having jurisdiction, more than one service is permitted to a multitenant building when there is no single space that would make the service equipment available to all tenants of the building.

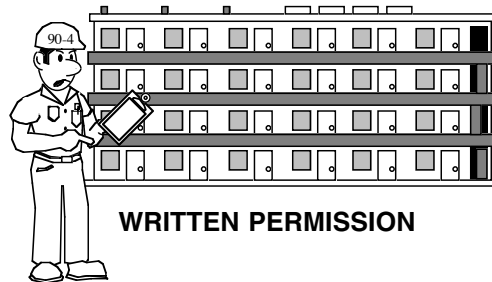

230.2(C)(1). This exception by special permission permits more than one service where the capacity requirements are over 2000 amps at 1000v or less and where single-phase load requirements are more than the power company normally supplies to one service.

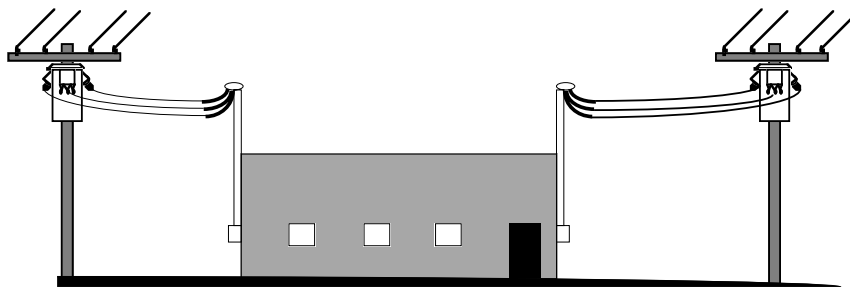

Special permission is given for more than one service to supply large areas such as high-rise buildings, shopping centers, industrial plants, etc.

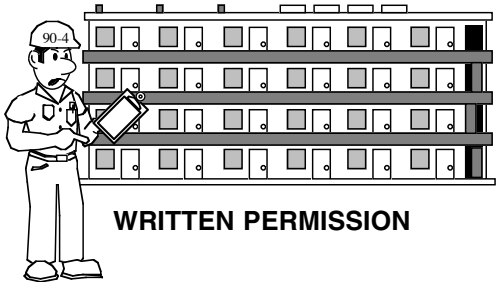

230.2(D). This exception permits more than one service to a building that requires different voltages, frequencies, phases, or for different uses, such as different rate schedules.

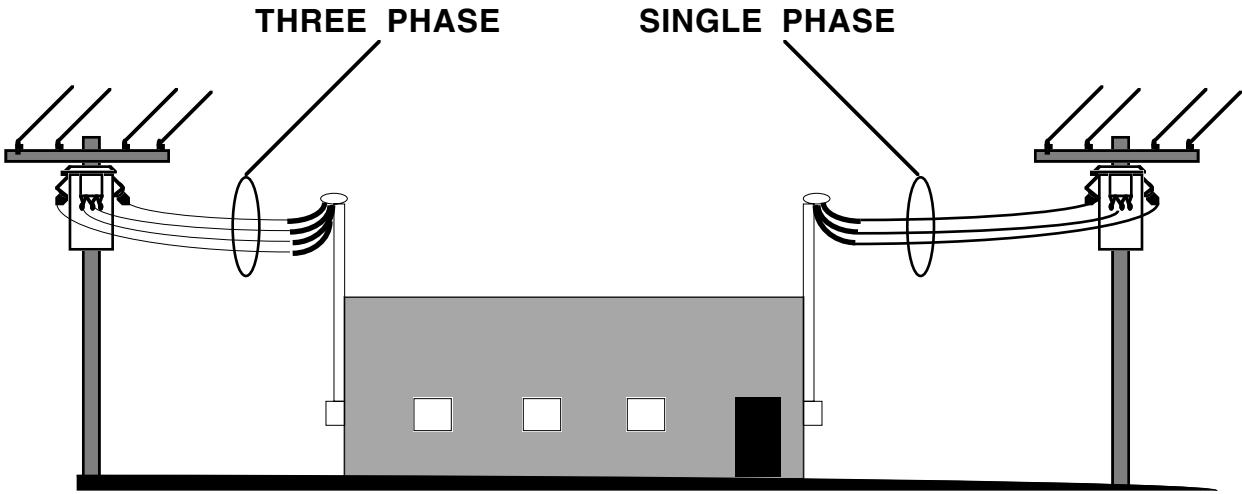

Separate service for special "off peak" rate for water heater

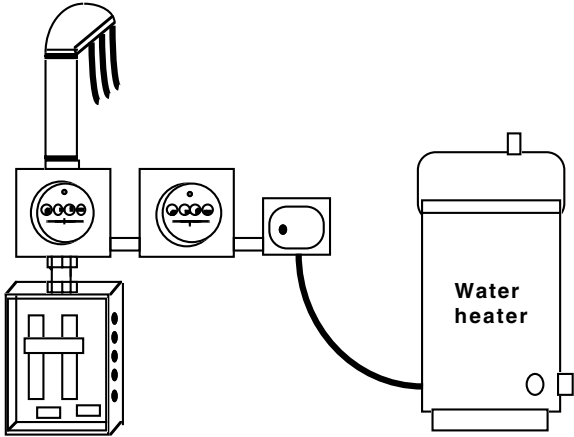

230.2(E)

230.2(E). A permanent plaque or directory shall be installed at each feeder or branch circuit disconnect location denoting all other services, feeders, and branch circuits supplying that building or structure and the area served by each.

**SERVICE #1 of two services.
Service #1 will disconnect the 1st
floor. SERVICE #2 is located in the
northeast corner of this building.**

← **The directory must be made of material to withstand the environment so that it remains legible**

230.3. Service conductors supplying a building or other structure shall **not** pass through the inside of another building or other structure. This is a very important rule of safety that must be followed. The overcurrent protection for service conductors is on the primary side of the transformer. In the event of a fault condition, the fault would have to burn clear in most cases. This is the reason that service conductors have separate rules from branch circuits and feeder conductors.

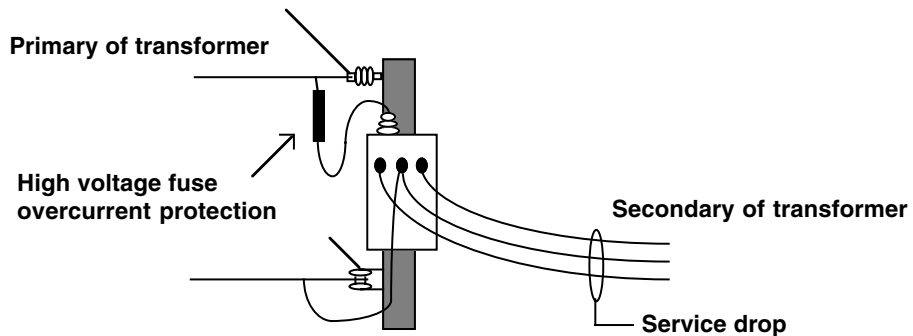

The definition of a building is a structure that stands alone or that is cut off from adjoining structures by fire walls with all openings therein protected by approved fire doors.

TWO BUILDINGS UNDER SAME ROOF

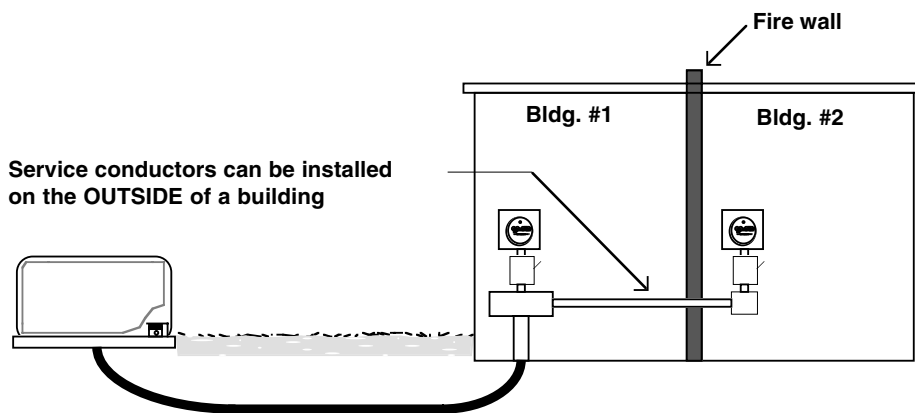
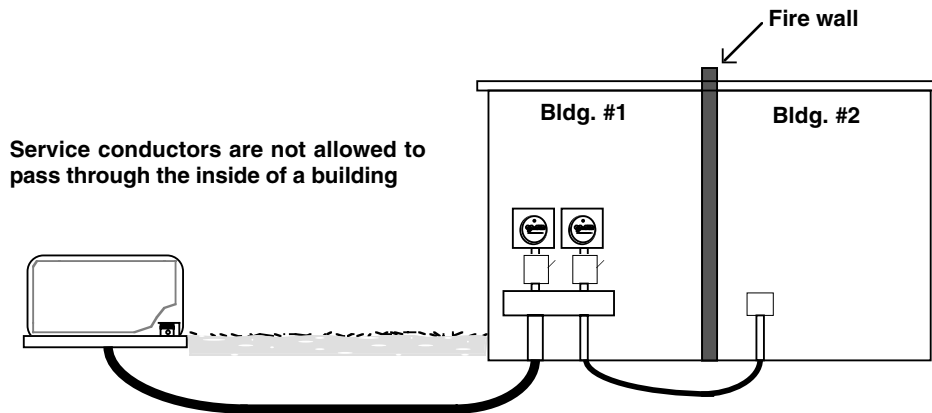
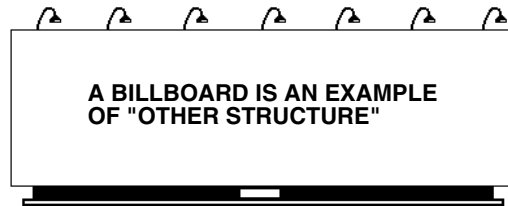
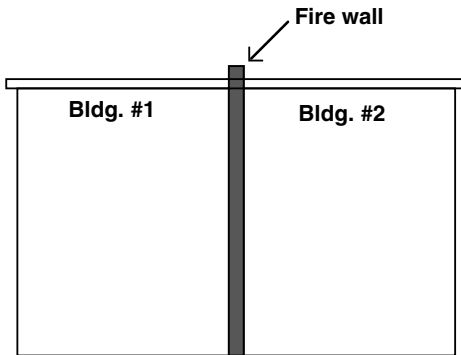

230.6. Conductors shall be considered **outside a building** under any of the following conditions:

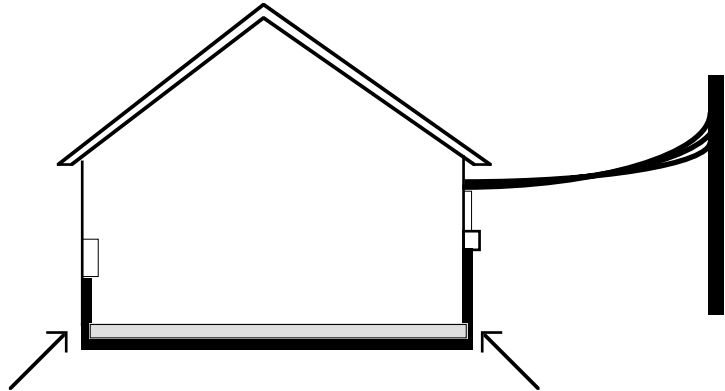

Where installed under not less than 2" of concrete beneath a building

Where **ENCASED** in not less than 2" of concrete or brick service raceway can be installed **INSIDE** a building

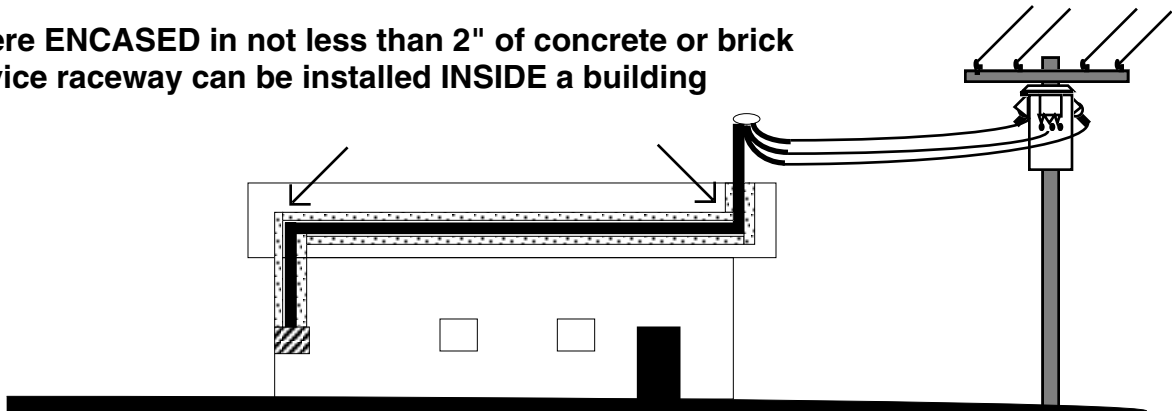

Service conductors are considered outside a building when installed in a transformer vault

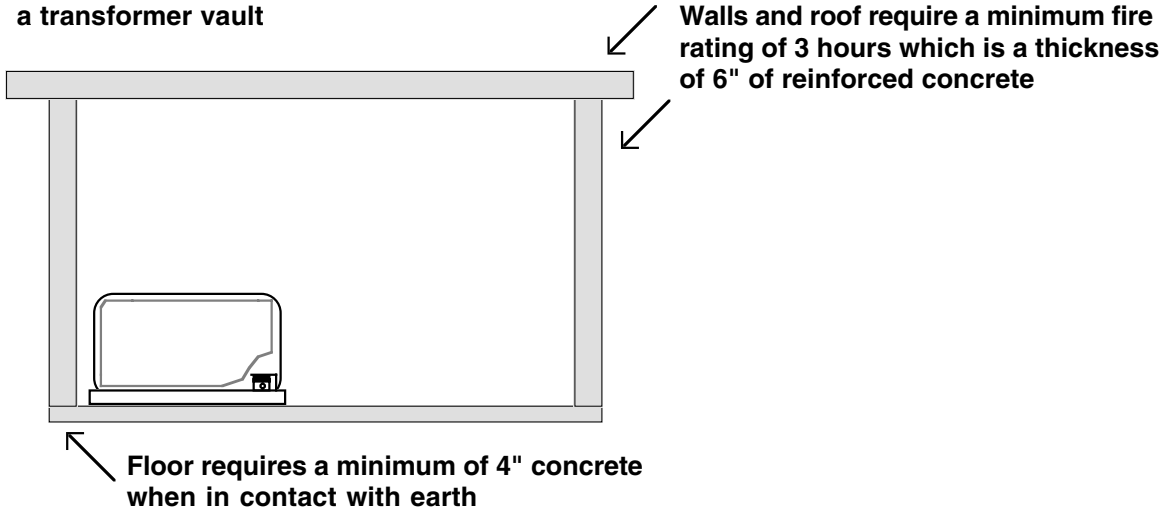

Walls and roof require a minimum fire rating of 3 hours which is a thickness of 6" of reinforced concrete

Floor requires a minimum of 4" concrete when in contact with earth

230.7. The general rule states no other conductors can be installed in the same service raceway or service cable. But there are two exceptions to this rule.

Exception 1. This exception permits grounding conductors and bonding jumpers to be installed with service conductors.

Exception 2. Load management control conductors that have overcurrent protection are permitted.

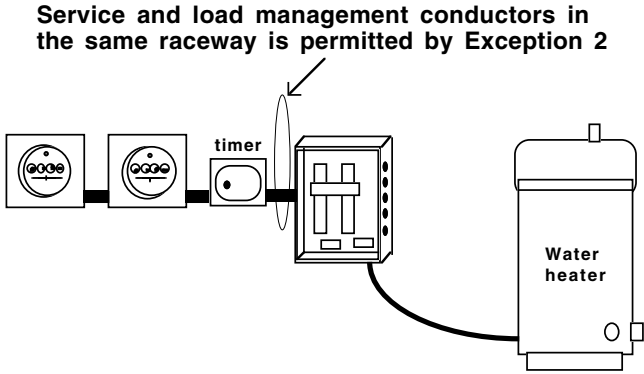

230.8. Sealants that are identified for use with cable insulation, shield, or other components shall be used where a service raceway, spare or unused raceways enter a building from underground.

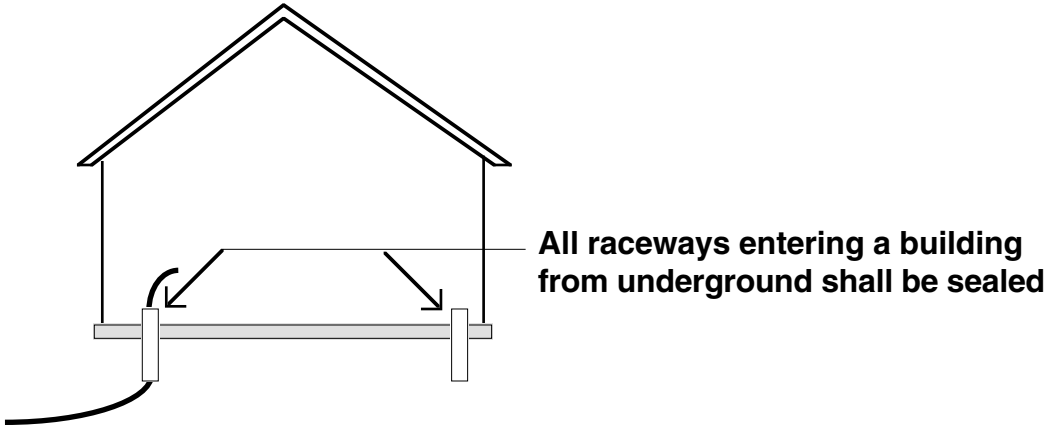

230.9(A)

230.9(A). Service drop conductors open or multiconductors (triplex) shall have a clearance of not less than 3' from windows, doors, porches, etc. that can be opened.

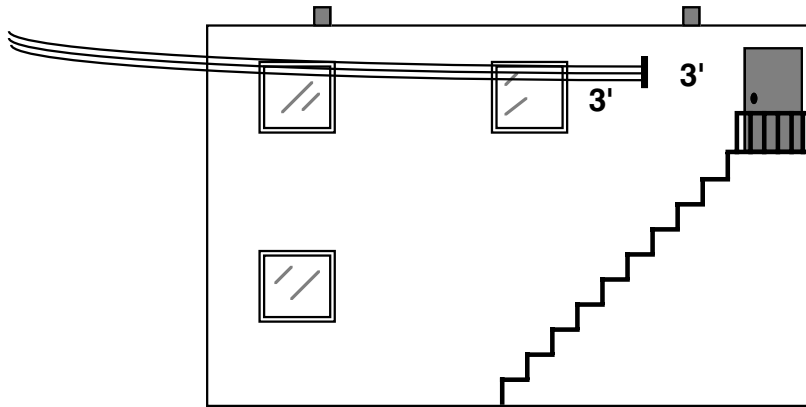

Exception. Conductors run *above the top* of a window are permitted to be less than 3'.

Overhead service conductors shall not be installed beneath openings where material may be moved.

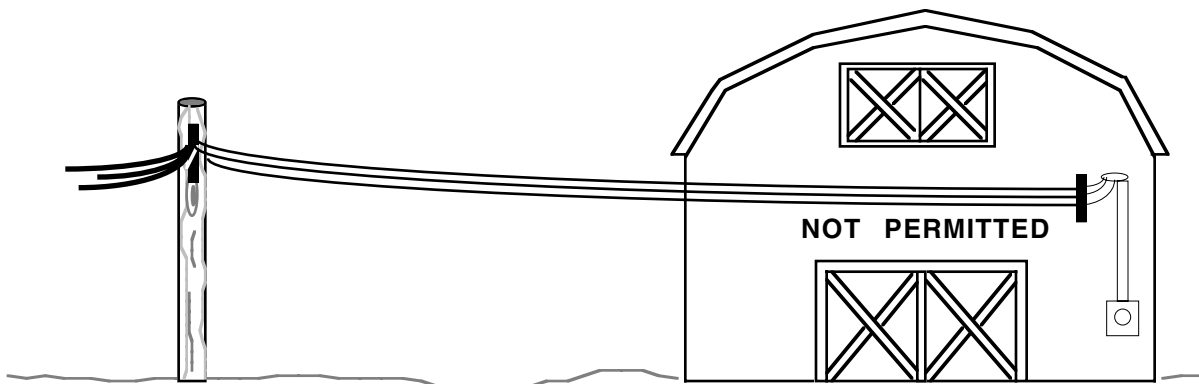

Part II. Overhead Service Conductors

230.22. The ungrounded (hot) service conductors are required to be insulated or covered.

UNGROUNDED (HOT) CONDUCTOR

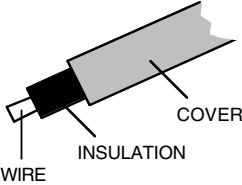

Exception. The only service conductor that is permitted to be bare is the grounded conductor.

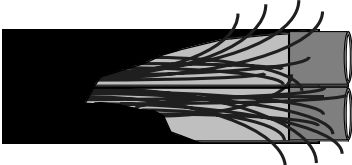

Only the grounded conductor is permitted to be bare

230.23(A). The service conductors shall be sized with an ampacity to carry the load without an increase in temperature rise. They shall also have adequate mechanical strength.

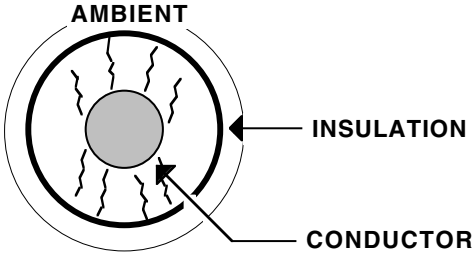

230.23(B)

230.23(B). The overhead service drop conductors shall not be smaller than #8 copper or #6 aluminum.

Exception. Limited loads of a single branch circuit shall not be smaller than #12 hard-drawn copper or equivalent.

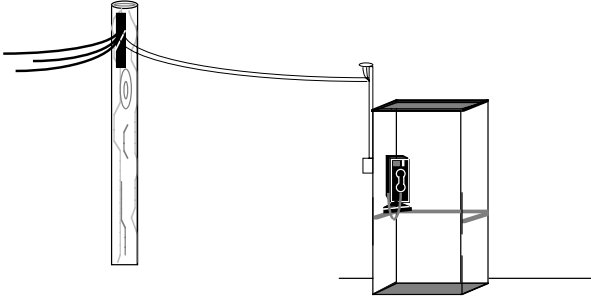

230.23(C). The grounded (neutral) conductor shall be sized from Table 250.24(D).



230.24. Overhead service conductors shall **not** be readily accessible.

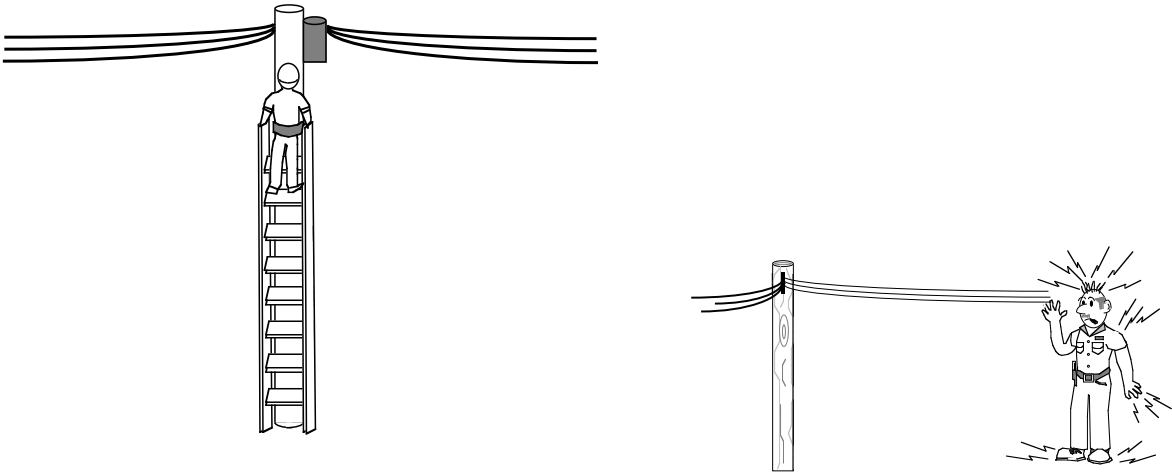

230.24(A)

230.24(A). Overhead service conductors shall have a vertical clearance of not less than *8 feet 6 inches* above the surface of the roof.

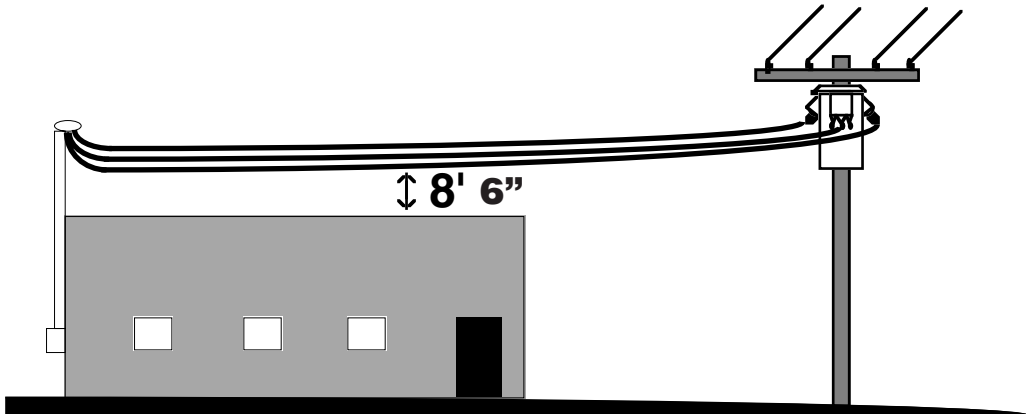

The vertical clearance above the roof level shall be maintained for a distance not less than 3 feet in all directions from the edge of the roof.

Exception 1. The area above a roof subject to pedestrian or vehicular traffic in cases such as a parking garage, shall have vertical clearances as in Section 230.24(B) as shown below.

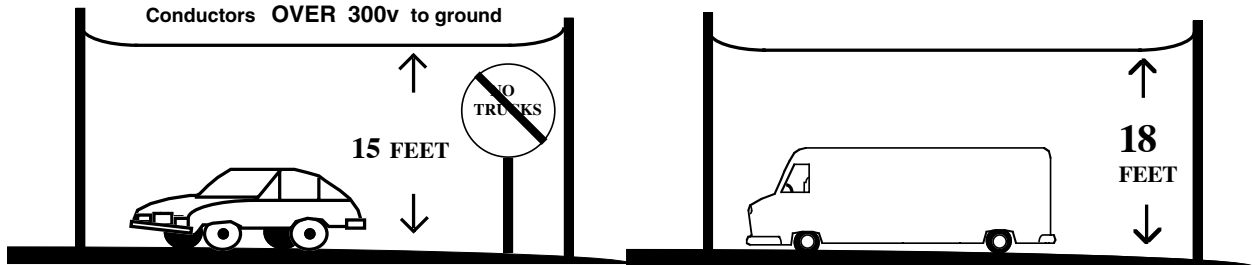
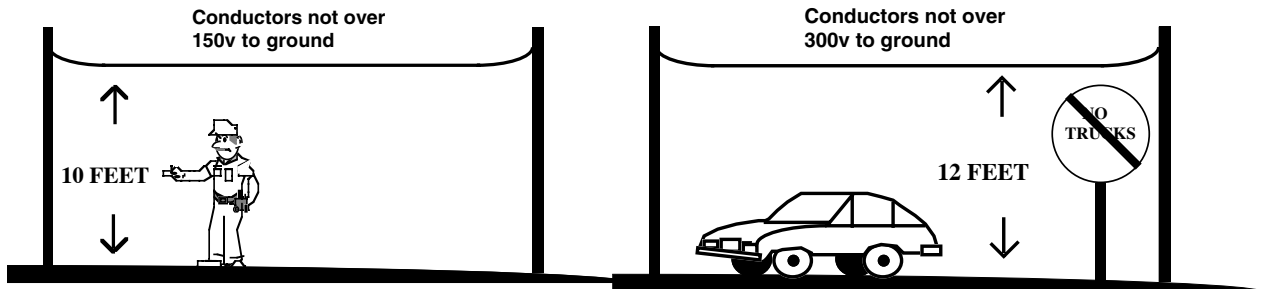

FINAL EXAM #3 - OPEN BOOK

•Circle your choice of answer and write the Code section where it was found.

1. The breaker shown below was installed on an ungrounded 240v delta-connected service.

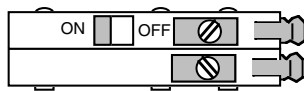

120/240v

OKAY VIOLATION

Code section _____.

2. A 16 amp continuous load is connected to a 20 amp rated circuit.

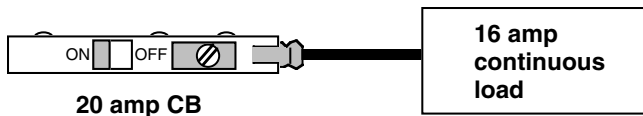

20 amp CB

OKAY VIOLATION

Code section _____.

3. A light on a tunnel is mounted 16' above grade level.

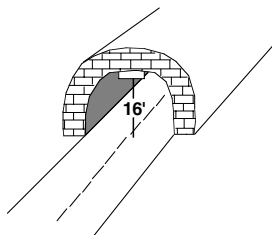

OKAY VIOLATION

Code section _____.

4. The service conductors are installed under the floor of the house beneath 2" of concrete.

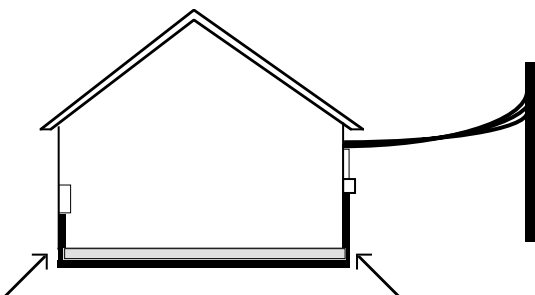

Installed under 2" of concrete beneath the building

OKAY VIOLATION

Code section _____.

5. Plug fuses are used on the 120v circuits of a 208/120v wye system.

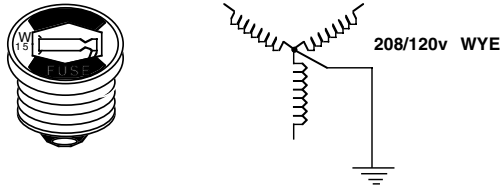

OKAY VIOLATION

Code section _____.

6. The circuit breaker handles are arranged in a switchboard as shown below.

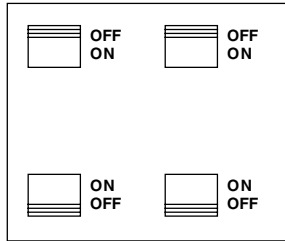

OKAY VIOLATION

Code section _____.

7. Festoon wiring is strung between poles 30 feet apart with no messenger wire support.

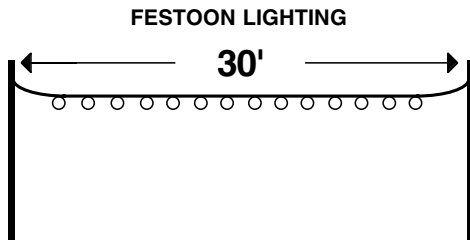

OKAY VIOLATION

Code section _____.

8. The 10 amp supplementary furnace fuse is located in an inaccessible location.

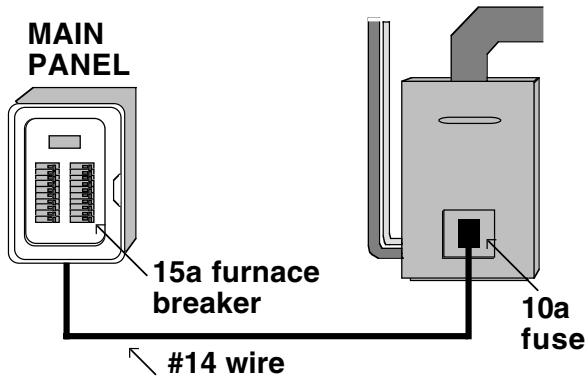

OKAY VIOLATION

Code section _____.

9. A 30 amp plug fuse is connected in series with the white wire.

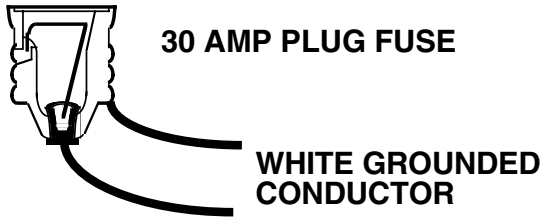

OKAY VIOLATION

Code section _____.

10. #6 THW conductors are tapped to #2/0 THW conductors to a motor.

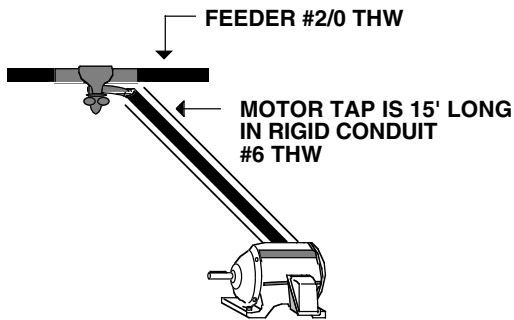

OKAY VIOLATION

Code section _____.

11. The feeder neutral to fluorescent light circuits is reduced 70% of the ungrounded conductors.

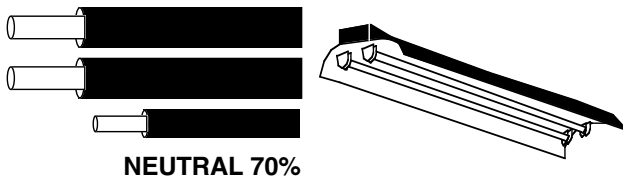

OKAY VIOLATION

Code section _____.

12. The industrial building (one building) shown below is fed by two services.

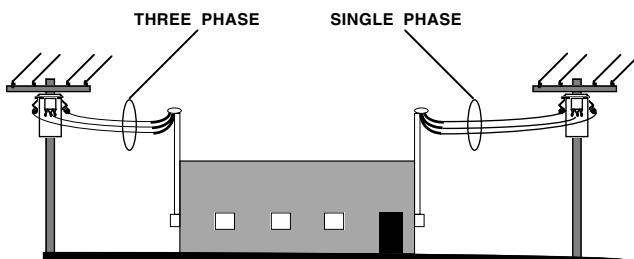

OKAY VIOLATION

Code section _____.

13. A single-family dwelling with 1000 sq.ft. of living area and an 8 kw range has a 60 amp service.

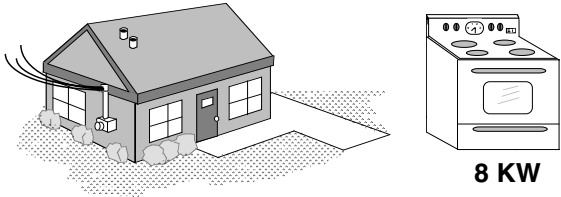

OKAY VIOLATION

Code section _____.

14. The handle of the busway overcurrent device is more than 6 1/2' above the floor or platform.

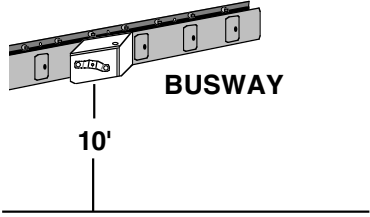

OKAY VIOLATION

Code section _____.

15. The overload relay also provides overcurrent protection for the motor circuit.

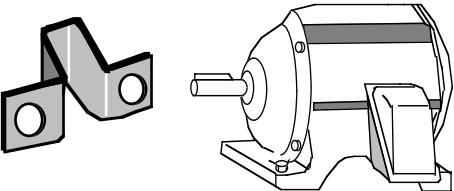

OKAY VIOLATION

Code section _____.

16. A #16 AWG extension cord is plugged into a 30 amp rated circuit.

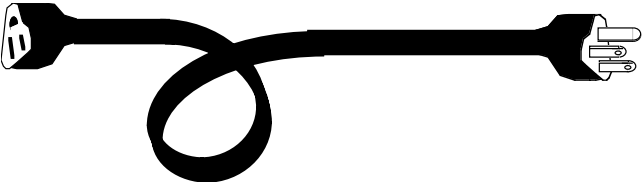

EXTENSION CORD #16 AWG

OKAY VIOLATION

Code section _____.



30 AMP RATED